

**LECTURE NOTES**

**ON**

**GROUND IMPROVEMENT TECHNIQUES**

# UNIT-1

## Introduction to Engineering Ground Modification.

**The Need for Engineered Ground Improvement:** As more and more land becomes subject to urban or industrial development, good construction sites and borrow areas are difficult to find and the soil improvement alternatives becomes the best option, technically and economically.

Where a project encounters difficult foundation conditions, possible alternative solutions are:

1. Avoid the particular site. Relocate a planned highway or development site.
2. **Design** the planned structure accordingly. Some of the many possible approaches are to:
  - Use a raft foundation supported by piles,
  - Design a very stiff structure which is not damaged by settlement,
  - Or choose a very flexible construction which accommodates differential movement or allows for compensation.
3. **Remove and replace** unsuitable soils. Removing organic **topsoil**, which is soft, compressible, and volumetrically unstable.

This is a standard precaution in road or foundation construction.

4. Attempt to **modify the existing ground**

## Objective of Ground Improvement Techniques

The most common traditional objectives include improvement of the soil and ground for use as a foundation or construction material.

The typical Engineering objectives have been:

- 1) Increasing shear strength, durability, stiffness. And stability:
- 2) Mitigating undesirable properties (eg. Shrink/ swell potential, compressibility, liquefability
- 3) Modifying permeability, the rate of fluid to flow through a medium; and
- 4) Improving efficiency and productivity by using methods that save time and expense,

The engineer must take a determination on how best to achieve the desired goals required by providing a workable solution for each project encountered. Ground improvement methods have provided adverse choice of approaches to solving these challenges.

## **Factors affecting choice of improvement method**

1. **Soil type** : this is one of the most important parameters that will control what approach or materials will be applicable to only certain types of soil types and grain sizes
2. **Area** , depth and location of treatment required- many ground improvement methods have depth limitations that render them unsuitable for applications for deeper soil horizons.
3. **Desired/required soil properties**- obviously, different methods are use to achieve different engineering properties, and certain methods will provide various levels of uniformity to improved sites.
4. **Availability of materials**- Depending on the location of the project and materials required for each fesible ground improvements approach.
5. **Availability of skills**, local experience, and local preferences- While the engineer may possess the knowledge and understanding of a preferred method.
6. **Environmental concerns**- With a better understanding and a greater awareness of effects on the natural environment, more attention have been placed on methods that assure less environmental impacts.
7. **Economics**- when all else has been considered, the final decision on choice of improvement method will often come down to the ultimate cost of a proposed method, or cost will be the deciding factor in choosing between two or more otherwise suitable methods.

## **Identifying your soil type**

**Soils can be identified in to their general types by the way they feel and respond to handling...**

Pick up a handful and squeeze it together. Sand feels gritty and the grains do not stick together when squeezed. Loam feels velvety or flour-like when dry and forms a weak ball shape when wet which crumbles apart when dry. Clay feels sticky, but goes smooth when rubbed. Chalk will have large lumps in it and be hard to mould.

## **How to work with your soil**

The most important thing is to identify your soil type and work with it, remember the golden rule All soil types have their good points and can be improved. Even the best loam soils will benefit from additional organic matter.

### **Heavy, Clay soil**

This holds water, but also bakes dry in the summer. However, clay is very good at holding nutrients and moisture and very fertile as long as you can break it down with the addition of organic matter and grit. This will enable the roots of plants to get through to the nutrients more easily and of course make planting less back breaking for you. Try and avoid walking on the soil too much as this will compact it to a hard pan.

### **Sandy soil**

It loses water very quickly being particularly free-draining. However, you can improve both of these factors with the addition of organic matter and soil improver and of course, many plants thrive in a free-draining soil. It also warms up quickly in the spring.

### **Chalky**

This is alkaline so will not suit plants that require ericaceous soil. Some soils contain large clumps of chalk; others are a mixture of chalk and clay. It is normally free draining, but may be low in nutrients so as with the other soils the addition of organic matter will help with both the structure and nutritional content of the soil.

### **Normal**

It retains moisture without impeding drainage, captures nutrients and allows oxygen to circulate. It normally contains equal quantities of sand, clay, silt, and organic matter.

### **Loam, Sand & Silt Soil Identification**



Soil type affects drainage.

Many plants are quite picky about the type of soil in which they live. Therefore, identifying your garden's kind of soil will help you know whether particular plants will do well in your garden without soil amendment or with soil amendment, or if you should just skip using those plants altogether.

### **Sandy Soil**

Most people associate sandy textures with those they feel between their toes at the beach, and the feeling is similar in sandy soil. Its particles are the largest of all the soil particle types, ranging from 0.05 to 0.10 millimeters at the small end and 1 to 2 millimeters at the large end. That factor gives wet or dry sandy soil a grainy texture when you rub it between your fingers, and it makes the soil light and crumbly even when you try to stick it together in your hand. Sandy soil drains very quickly.

### **Silt Soil**

Many people think of loam as the intermediate between sand and clay, but midsized soil particles are referred to as silt. Silt soil is fine and feels almost floury to the touch when dry. When wet, it

becomes a smooth mud that you can form easily into balls or other shapes in your hand. When silt soil is very wet, it blends seamlessly with water to form fine, runny puddles of mud. Silt particles are very small, between 0.002 and 0.05 millimeters, which results in their very smooth texture. Silty soil drains well but not as quickly as sand.

### **Clay Soil**

Clay particles are the finest of all the soil particles, measuring fewer than 0.002 millimeters in size. They stick together readily and form a sticky or gluey texture when they are wet or dry. When you gather clay soil into your hand, you can readily shape it into whatever form you want. It will form a ball that doesn't break when squeezed, or a thin, flexible ribbon when pressed between your thumb and forefinger.

### **Loam Soil**

Loam is not its own particle type but a designation for soils containing certain combinations of other particles. The way the other particles combine in the soil makes the loam. For instance, a soil that is 30 percent clay, 50 percent sand and 20 percent silt is a sandy clay loam, with the soil types before "loam" listed in the order their particles are most dominant in the loam. The labels "clay loam," "silt loam" and "sand loam" are used to refer to soils that are composed predominantly of those ingredients.

### **In situ laboratory test for problematic Soils**

#### **In Situ and Laboratory Testing**

**ESG's (Environmental, Social and Governance)** geotechnical division offers a wide range of in situ and laboratory-based testing methods for the measurement of soil and rock stiffness parameters. In recent years the importance of soil and rock stiffness parameters in geotechnical engineering design has been increasingly recognized, driven in part by the requirements of EC-7 for calculating serviceability limit state conditions.

Specialist in situ testing

We provide a number of specialist in situ tests for the measurement of soil stiffness, either as a standalone service or part of a wider site investigation, backed up by proven technical and analytical expertise:

- Borehole and surface seismic methods, such as down hole, cross hole, surface refraction and multichannel analysis of surface waves (MASW)
- Seismic cone penetration testing (SCPT), a version of the down hole method where a seismic receiver is incorporated with conventional cone penetration testing (CPT)
- Pressure meter testing using pre-bored high pressure dilatometer (HPD), self-boring pressuremeter (SBP) and driven pressure meter (DPM) to carry out load displacement tests in boreholes

The adoption of EC-7, which advocates the direct measurement of geotechnical parameters by in situ testing techniques, has seen a significant increase in the demand for SBP and HPD testing methods.

Following a major period of investment, ESG's in situ team now offers combined magnetometer/piezocene resources and upgraded down hole magnetometer analysis, as well as the capability for site clearance with the potential risk of Unexploded Ordnance. In addition, our main cone penetration test rigs have undergone a program of detailed refurbishment to ensure they provide the best possible results.

### **Advanced laboratory testing**

Alongside in situ testing, we also provide extensive sample analysis in our UKAS accredited computer-based laboratories:

- Resonant column and simple shear apparatus, which provide soil stiffness and damping parameters over a range of strain amplitudes
- Triaxial tests with local strain and mid-height pore water pressure measurement to obtain strength and stiffness properties, while significantly reducing the influences of sample

bedding, end effects and allowing a much greater degree of precision of stress and strain measurement, together with automated control of all stages of testing

- Bender elements, either stand-alone or combined with other tests, to measure elastic wave travel times for calculation of wave velocities and stiffness

### **In situ sampling methods**

ESG offers a range of sampling methods to maximize undisturbed sample recovery in a variety of soil and rock ground conditions suitable for advanced testing methods, including:

- Thin-walled open drive tube samples (UT100)
- Thin-walled pushed samples (Shelby) and hydraulically-pushed piston samples
- Block samples
- Wireline rotary cored samples

### **Various Lab Test on Soil**

Soil inspection or say geotechnical inspection is very important in understanding the physical properties of soil and the rocks beneath. This is required to ascertain the type of foundation required for the proposed construction. Various tests are done to explore the sub surface and surface characteristics of soil .Some of these are given below. Just click on the link to go to the details of that particular test.

**1) Water Content** – There are two tests which can be done to determine the water content of soil. These are

a) Calcium Carbide Method

#### **Determining Water Content in Soil – Calcium Carbide Method**

This test is done to determine the water content in soil by calcium carbide method as per IS: 2720 (Part II) – 1973. It is a method for rapid determination of water content from the gas pressure developed by the reaction of calcium carbide with the free water of the soil. From the calibrated scale of the pressure gauge the percentage of water on total mass of wet soil is obtained and the same is converted to water content on dry mass of soil.



### **Apparatus required:-**

- i) Metallic pressure vessel, with a clamp for sealing the cup, alongwith a gauge calibrated in percentage water content
- ii) Counterpoised balance, for weighing the sample
- iii) Scoop, for measuring the absorbent (Calcium Carbide)
- iv) Steel balls – 3 steel balls of about 12.5mm dia. and 1 steel ball of 25mm dia.
- v) One bottle of the absorbent (Calcium Carbide)

### **PREPARATION OF SAMPLE**

Sand – No special preparation. Coarse powders may be ground and pulverized. Cohesive and plastic soil – Soil is tested with addition of steel ball in the pressure vessels. The test requires about 6g of sample.

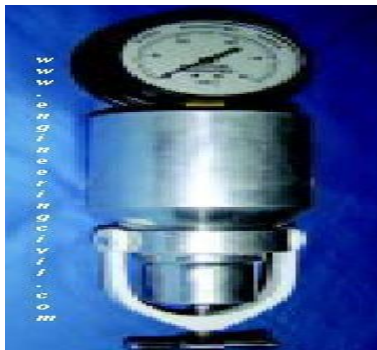

### **Procedure to determine Water Content in Soil by Calcium Carbide Method**

- i) Set up the balance, place the sample in the pan till the mark on the balance arm matches with the index mark.
- ii) Check that the cup and the body are clean.
- iii) Hold the body horizontally and gently deposit the leveled, scoop-full of the absorbent (Calcium Carbide) inside the chamber.
- iv) Transfer the weighed soil from the pan to the cup.
- V) Hold cup and chamber horizontally, bringing them together without disturbing the sample and the absorbent.

vi) Clamp the cup tightly into place. If the sample is bulky, reverse the above placement, that is, put the sample in the chamber and the absorbent in the cup.

vii) In case of clayey soils, place all the 4 steel balls (3 smaller and 1 bigger) in the body along with the absorbent.

viii) Shake the unit up and down vigorously in this position for about 15 seconds.

ix) Hold the unit horizontally, rotating it for 10 seconds, so that the balls roll around the inner circumference of the body.

x) Rest for 20 seconds.

xi) Repeat the above cycle until the pressure gauge reading is constant and note the reading. Usually it takes 4 to 8 minutes to achieve constant reading. This is the water content (m) obtained on wet mass basis.

xii) Finally, release the pressure slowly by opening the clamp screw and taking the cup out, empty the contents and clean the instrument with a brush.

## b) Oven Drying Method

### **Determining Water Content in Soil – Oven Drying Method**

This test is done to determine the water content in soil by oven drying method as per IS: 2720 (Part II) – 1973. The water content (w) of a soil sample is equal to the mass of water divided by the mass of solids.

Apparatus required:-

- i) Thermostatically controlled oven maintained at a temperature of  $110 \pm 5^{\circ}\text{C}$
- ii) Weighing balance, with an accuracy of 0.04% of the weight of the soil taken
- iii) Air-tight container made of non-corrodible material with lid Tongs

### **PREPARATION OF SAMPLE**

The soil specimen should be representative of the soil mass. The quantity of the specimen taken would depend upon the gradation and the maximum size of particles as under:

### **Procedure to determine Water Content in Soil By Oven Drying Method**

- i) Clean the container, dry it and weigh it with the lid (Weight „W<sub>1</sub>,,).

- ii) Take the required quantity of the wet soil specimen in the container and weigh it with the lid (Weight „W<sub>2</sub>,,).
- iii) Place the container, with its lid removed, in the oven till its weight becomes constant (Normally for 24hrs.).
- iv) When the soil has dried, remove the container from the oven, using tongs.
- v) Find the weight „W<sub>3</sub>,,of the container with the lid and the dry soil sample.

## **2) Free Swell Index Of Soil**

To determine the free swell index of soil as per IS: 2720 (Part XL) – 1977. Free swell or differential free swell, also termed as free swell index, is the increase in volume of soil without any external constraint when subjected to submergence in water. The apparatus used:

- i) IS Sieve of size 425µm?
  - ii) Oven
  - iii) Balance, with an accuracy of 0.01g
  - iv) Graduated glass cylinder- 2 nos., each of 100ml capacity
- Procedure to determine Free Swell Index of Soil
- v) Take two specimens of 10g each of pulverized soil passing through 425µm IS Sieve and oven-dry.ii) Pour each soil specimen into a graduated glass cylinder of 100ml capacity.iii) Pour distilled water in one and kerosene oil in the other cylinder upto 100 ml mark.
  - iv) Remove entrapped air by gently shaking or stirring with a glass rod.
  - v) Allow the suspension to attain the state of equilibrium (for not less than 24hours).
  - vi) Final volume of soil in each of the cylinder should be read out.

## **3) Plastic Limit of Soil**

### **Determine the Plastic Limit of Soil**

This test is done to determine the plastic limit of soil as per IS: 2720 (Part 5) – 1985. The plastic limit of fine-grained soil is the water content of the soil below which it ceases to be plastic. It begins to crumble when rolled into threads of 3mm dia. The apparatus used:

- i) Porcelain evaporating dish about 120mm dia.
- ii) Spatula
- iii) Container to determine moisture content
- iv) Balance, with an accuracy of 0.01g
- v) Oven
- vi) Ground glass plate – 20cm x 15cm
- vii) Rod – 3mm dia. and about 10cm long

### **PREPARATION OF SAMPLE**

Take out 30g of air-dried soil from a thoroughly mixed sample of the soil passing through 425 $\mu$ m IS Sieve. Mix the soil with distilled water in an evaporating dish and leave the soil mass for nurturing. This period may be up to 24hrs.

### **Procedure to determine The Plastic Limit of Soil**

- i) Take about 8g of the soil and roll it with fingers on a glass plate. The rate of rolling should be between 80 to 90 strokes per minute to form a 3mm dia.
- ii) If the dia. of the threads can be reduced to less than 3mm, without any cracks appearing, it means that the water content is more than its plastic limit. Knead the soil to reduce the water content and roll it into a thread again.
- iii) Repeat the process of alternate rolling and kneading until the thread crumbles.
- iv) Collect and keep the pieces of crumbled soil thread in the container used to determine the moisture content.
- v) Repeat the process at least twice more with fresh samples of plastic soil each time.

### **4) Liquid Limit Of Soil**

This test is done to determine the liquid limit of soil as per IS: 2720 (Part 5) – 1985. The liquid limit of fine-grained soil is the water content at which soil behaves practically like a liquid, but

has small shear strength. Its flow closes the groove in just 25 blows in Casagrande's liquid limit device. The apparatus used :-

- i) Casagrande's liquid limit device
- ii) Grooving tools of both standard and ASTM types
- iii) Oven
- iv) Evaporating dish
- v) Spatula
- vi) IS Sieve of size 425 $\mu$ m
- vii) Weighing balance, with 0.01g accuracy
- viii) Wash bottle
- ix) Air-tight and non-corrodible container for determination of moisture content

#### **PREPARATION OF SAMPLE**

- i) Air-dry the soil sample and break the clods. Remove the organic matter like tree roots, pieces of bark, etc.
- ii) About 100g of the specimen passing through 425 $\mu$ m IS Sieve is mixed thoroughly with distilled water in the evaporating dish and left for 24hrs. for soaking.



6)

### **Procedure to Determine The Liquid Limit of Soil**

- i) Place a portion of the paste in the cup of the liquid limit device.
- ii) Level the mix so as to have a maximum depth of 1cm.
- iii) Draw the grooving tool through the sample along the symmetrical axis of the cup, holding the tool perpendicular to the cup.
- iv) For normal fine grained soil: The Casagrande's tool is used to cut a groove 2mm wide at the bottom, 11mm wide at the top and 8mm deep.
- v) For sandy soil: The ASTM tool is used to cut a groove 2mm wide at the bottom, 13.6mm wide at the top and 10mm deep.
- vi) After the soil pat has been cut by a proper grooving tool, the handle is rotated at the rate of about 2 revolutions per second and the no. of blows counted, till the two parts of the soil sample come into contact for about 10mm length.
- vii) Take about 10g of soil near the closed groove and determine its water content
- viii) The soil of the cup is transferred to the dish containing the soil paste and mixed thoroughly after adding a little more water. Repeat the test.

ix) By altering the water content of the soil and repeating the foregoing operations, obtain at least 5 readings in the range of 15 to 35 blows. Don't mix dry soil to change its consistency.

x) Liquid limit is determined by plotting a „flow curve“ on a semi-log graph, with no. of blows as abscissa (log scale) and the water content as ordinate and drawing the best straight line through the plotted points.

## **5) Particle Size Distribution Of Soil**

### **Determine Particle Size Distribution of Soil**

This test is done to determine the particle size distribution of soil as per IS: 2720 (Part 4) – 1985.

The apparatus required to do this test :-

- i) A set of fine IS Sieves of sizes – 2mm, 600 $\mu$ m, 425 $\mu$ m, 212 $\mu$ m and 75 $\mu$ m
- ii) A set of coarse IS Sieves of sizes – 20mm, 10mm and 4.75mm
- iii) Weighing balance, with an accuracy of 0.1% of the weight of sample
- iv) Oven
- v) Mechanical shaker
- vi) Mortar with rubber pestle Brushes

viii) Trays

### **PREPARATION OF SAMPLE**

i) Soil sample, as received from the field, should be dried in air or in the sun. In wet weather, the drying apparatus may be used in which case the temperature of the sample should not exceed 60°C. The clod may be broken with wooden mallet to hasten drying. Tree roots and pieces of bark should be removed from the sample.

ii) The big clods may be broken with the help of wooden mallet. Care should be taken not to break the individual soil particles.

iii) A representative soil sample of required quantity as given below is taken and dried in the oven at 105 to 120°C.

Maximum size of material present in substantial quantities (mm)	Weight to be taken for test (kg)
75	60
40	25
25	13
19	6.5
12.5	3.5
10	1.5
6.5	0.75
4.75	0.4

### **Procedure to determine Particle Size Distribution Of Soil**

- i) The dried sample is taken in a tray, soaked in water and mixed with either 2g of sodium hexametaphosphate or 1g of sodium hydroxide and 1g of sodium carbonate per litre of water, which is added as a dispersive agent. The soaking of soil is continued for 10 to 12hrs.
- ii) The sample is washed through 4.75mm IS Sieve with water till substantially clean water comes out. Retained sample on 4.75mm IS Sieve should be oven-dried for 24hrs. This dried sample is sieved through 20mm and 10mm IS Sieves.
- iii) The portion passing through 4.75mm IS Sieve should be oven-dried for 24hrs. This oven-dried material is riffled and about 200g taken.
- iv) This sample of about 200g is washed through 75 $\mu$ m IS Sieve with half litre distilled water, till substantially clear water comes out.
- v) The material retained on 75 $\mu$ m IS Sieve is collected and dried in oven at a temperature of 105 to 120°C for 24hrs. The dried soil sample is sieved through 2mm, 600 $\mu$ m, 425 $\mu$ m and 212 $\mu$ m IS Sieves. Soil retained on each sieve is weighed.
- vi) If the soil passing 75 $\mu$ m is 10% or more, hydrometer method is used to analyse soil particle size.

### **6) The Specific Gravity Of Soil**

**Determine the Specific Gravity of Soil**



This test is done to determine the specific gravity of fine-grained soil by density bottle method as per IS: 2720 (Part III/Sec 1) – 1980. Specific gravity is the ratio of the weight in air of a given volume

of a material at a standard temperature to the weight in air of an equal volume of distilled water at the same stated temperature.

The apparatus used:

- i) Two density bottles of approximately 50ml capacity along with stoppers
- ii) Constant temperature water bath ( $27.0 \pm 0.2^\circ\text{C}$ )
- iii) Vacuum desiccators
- iv) Oven, capable of maintaining a temperature of 105 to  $110^\circ\text{C}$
- v) Weighing balance, with an accuracy of 0.001g
- vi) Spatula

### **PREPARATION OF SAMPLE**

The soil sample (50g) should if necessary be ground to pass through a 2mm IS Sieve. A 5 to 10g sub-sample should be obtained by riffing and oven-dried at a temperature of 105 to  $110^\circ\text{C}$ .

### **Procedure to Determine the Specific Gravity of Fine-Grained Soil**

- i) The density bottle along with the stopper, should be dried at a temperature of 105 to  $110^\circ\text{C}$ , cooled in the desiccators and weighed to the nearest 0.001g ( $W_1$ ).
- ii) The sub-sample, which had been oven-dried should be transferred to the density bottle directly from the desiccators in which it was cooled. The bottles and contents together with the stopper should be weighed to the nearest 0.001g ( $W_2$ ).
- iii) Cover the soil with air-free distilled water from the glass wash bottle and leave for a period of 2 to 3hrs. For soaking. Add water to fill the bottle to about half.

- iv) Entrapped air can be removed by heating the density bottle on a water bath or a sand bath.
- v) Keep the bottle without the stopper in a vacuum desiccator for about 1 to 2hrs. until there is no further loss of air.
- vi) Gently stir the soil in the density bottle with a clean glass rod, carefully wash off the adhering particles from the rod with some drops of distilled water and see that no more soil particles are lost.
- vii) Repeat the process till no more air bubbles are observed in the soil-water mixture.
- viii) Observe the constant temperature in the bottle and record.
- ix) Insert the stopper in the density bottle, wipe and weigh( $W_3$ ).
- x) Now empty the bottle, clean thoroughly and fill the density bottle with distilled water at the same temperature. Insert the stopper in the bottle, wipe dry from the outside and weigh ( $W_4$ ).
- xi) Take at least two such observations for the same soil.

## **7) The In-Situ Dry Density Of Soil By Sand Replacement Method**

### **Determine the In-Situ Dry Density of Soil by Sand Replacement Method**

This test is done to determine the in-situ dry density of soil by sand replacement method as per IS: 2720 (Part XXVIII) – 1974. The apparatus needed is

- i) Sand-pouring cylinder conforming to IS: 2720 (Part XXVIII) -1974
- ii) Cylindrical calibrating container conforming to IS: 2720 (Part XXVIII) – 1974
- iii) Soil cutting and excavating tools such as a scraper tool, bent spoon
- iv) Glass plate – 450mm square and 9mm thick or larger
- v) Metal containers to collect excavated soil
- vi) Metal tray – 300mm square and 40mm deep with a 100mm hole in the centre
- vii) Balance, with an accuracy of 1g

### **Procedure to Determine The In-Situ Dry Density Of Soil By Sand Replacement Method**

#### A. Calibration of apparatus

**a) The method given below should be followed for the determination of the weight of sand in the cone of the pouring cylinder:**

b) The pouring cylinder should be filled so that the level of the sand in the cylinder is within about 10 mm of the top. Its total initial weight ( $W_1$ ) should be maintained constant throughout the tests for which the calibration is used. A volume of sand equivalent to that of the excavated hole in the soil (or equal to that of the calibrating container) should be allowed to run out of the cylinder under gravity. The shutter of the pouring cylinder should then be closed and the cylinder placed on a plain surface, such as a glass plate.

ii) The shutter of the pouring cylinder should be opened and sand allowed to run out. When no further movement of sand takes place in the cylinder, the shutter should be closed and the cylinder removed carefully.

iii) The sand that had filled the cone of the pouring cylinder (that is, the sand that is left on the plain surface) should be collected and weighed to the nearest gram.

iv) These measurements should be repeated at least thrice and the mean weight ( $W_2$ ) taken.

**b) The method described below should be followed for the determination of the bulk density of the sand ( $Y_s$ ):**

i) The internal volume ( $V$ ) in ml of the calibrating container should be determined from the weight of water contained in the container when filled to the brim. The volume may also be calculated from the measured internal dimensions of the container.

ii) The pouring cylinder should be placed concentrically on the top of the calibrating container after being filled to the constant weight ( $W_1$ ). The shutter of the pouring cylinder should be closed during the operation. The shutter should be opened and sand allowed to run out. When no further movement of sand takes place in the cylinder, the shutter should be closed. The pouring cylinder should be removed and weighed to the nearest gram.

iii) These measurements should be repeated at least thrice and the mean weight ( $W_3$ ) taken.

## **B. Measurement of soil density**

The following method should be followed for the measurement of soil density:

- i) A flat area, approximately 450sq. mm of the soil to be tested should be exposed and trimmed down to a level surface, preferably with the aid of the scraper tool.
  
- ii) The metal tray with a central hole should be laid on the prepared surface of the soil with the hole over the portion of the soil to be tested. The hole in the soil should then be excavated using the hole in the tray as a pattern, to the depth of the layer to be tested upto a maximum of 150mm. The excavated soil should be carefully collected, leaving no loose material in the hole and weighed to the nearest gram( $W_w$ ). The metal tray should be removed before the pouring cylinder is placed in position over the excavated hole.
  
- iii) The water content ( $w$ ) of the excavated soil should be determined as discussed in earlier posts. Alternatively, the whole of the excavated soil should be dried and weighed ( $W_d$ ).
  
- iv) The pouring cylinder, filled to the constant weight ( $W_1$ ) should be so placed that the base of the cylinder covers the hole concentrically. The shutter should then be opened and sand allowed to runout into the hole. The pouring cylinder and the surrounding area should not be vibrated during this period. When no further movement of sand takes place, the shutter should be closed. The cylinder should be removed and weighed to the nearest gram ( $W_4$ ).

## **8) The In-Situ Dry Density Of Soil By Core Cutter Method**

### **Determine The In-Situ Dry Density Of Soil By Core Cutter Method**

This test is done to determine the in-situ dry density of soil by core cutter method as per IS: 2720 (Part XXIX) – 1975. The apparatus needed for this test is

- i) Cylindrical core cutter
- ii) Steel dolley
- iii) Steel rammer
- iv) Balance, with an accuracy of 1g
- v) Straightedge
- vi) Square metal tray – 300mm x 300mm x 40mm
- vii) Trowel

### **Procedure Determine The In-Situ Dry Density Of Soil By Core Cutter Method**

- i) The internal volume ( $V$ ) of the core cutter in cc should be calculated from its dimensions which should be measured to the nearest 0.25mm.
- ii) The core cutter should be weighed to the nearest gram ( $W_1$ ).



- iii) A small area, approximately 30cm square of the soil layer to be tested should be exposed and levelled. The steel dolly should be placed on top of the cutter and the latter should be rammed down vertically into the soil layer until only about 15mm of the dolly protrudes above the surface, care being taken not to rock the cutter. The cutter should then be dug out of the surrounding soil, care being taken to allow some soil to project from the lower end of the cutter. The ends of the soil core should then be trimmed flat in level with the ends of the cutter by means of the straightedge.
- iv) The cutter containing the soil core should be weighed to the nearest gram ( $W_2$ ).
- v) The soil core should be removed from the cutter and a representative sample should be placed in an air-tight container and its water content ( $w$ )

### **9) The Maximum Dry Density And The Optimum Moisture Content Of Soil**

**Apart from these some Soil Compaction Tests are also done. See this for details**

Determine The Maximum Dry Density And The Optimum Moisture Content Of Soil

This test is done to determine the maximum dry density and the optimum moisture content of soil using heavy compaction as per IS: 2720 (Part 8 ) – 1983. The apparatus used is

- i) Cylindrical metal mould – it should be either of 100mm dia. and 1000cc volume or 150mm dia. and 2250cc volume and should conform to IS: 10074 – 1982.
- ii) Balances – one of 10kg capacity, sensitive to 1g and the other of 200g capacity, sensitive to 0.01g
- iii) Oven – thermostatically controlled with an interior of noncorroding material to maintain temperature between 105 and 110°C
- iv) Steel straightedge – 30cm long
- v) IS Sieves of sizes – 4.75mm, 19mm and 37.5mm

### **PREPARATION OF SAMPLE**

A representative portion of air-dried soil material, large enough to provide about 6kg of material passing through a 19mm IS Sieve (for soils not susceptible to crushing during compaction) or about 15kg of material passing through a 19mm IS Sieve (for soils susceptible to crushing during compaction), should be taken. This portion should be sieved through a 19mm IS Sieve and the coarse fraction rejected after its proportion of the total sample has been recorded. Aggregations of particles should be broken down so that if the sample was sieved through a 4.75mm IS Sieve, only separated individual particles would be retained.

### **Procedure To Determine The Maximum Dry Density And The Optimum Moisture Content Of Soil**

A) Soil not susceptible to crushing during compaction –

- i) A 5kg sample of air-dried soil passing through the 19mm IS Sieve should be taken. The sample should be mixed thoroughly with a suitable amount of water depending on the soil type (for sandy and gravelly soil – 3 to 5% and for cohesive soil – 12 to 16% below the plastic limit). The soil sample should be stored in a sealed container for a minimum period of 16 hrs.
- ii) The mould of 1000cc capacity with base plate attached, should be weighed to the nearest 1g ( $W_1$ ). The mould should be placed on a solid base, such as a concrete floor or plinth and the moist soil should be compacted into the mould, with the extension attached, in five layers of

approximately equal mass, each layer being given 25 blows from the 4.9kg rammer dropped from a height of 450mm above the soil. The blows should be distributed uniformly over the surface of each layer. The amount of soil used should be sufficient to fill the mould, leaving not more than about 6mm to be struck off when the extension is removed. The extension should be removed and the compacted soil should be levelled off carefully to the top of the mould by means of the straight edge. The mould and soil should then be weighed to the nearest gram (W2).

iii) The compacted soil specimen should be removed from the mould and placed onto the mixing tray. The water content (w) of a representative sample of the specimen should be determined.

iv) The remaining soil specimen should be broken up, rubbed through 19mm IS Sieve and then mixed with the remaining original sample. Suitable increments of water should be added successively and mixed into the sample, and the above operations i.e. ii) to iv) should be repeated for each increment of water added. The total number of determinations made should be at least five and the moisture contents should be such that the optimum moisture content at which the maximum dry density occurs, lies within that range.

B) Soil susceptible to crushing during compaction –

Five or more 2.5kg samples of air-dried soil passing through the 19mm IS Sieve, should be taken. The samples should each be mixed thoroughly with different amounts of water and stored in a sealed container as mentioned in Part A)

C) Compaction in large size mould –

For compacting soil containing coarse material upto 37.5 mm sizes, the 2250cc mould should be used. A sample weighing about 30kg and passing through the 37.5mm IS Sieve is used for the test. Soil is compacted in five layers, each layer being given 55 blows of the 4.9kg rammer. The rest of the procedure is same as above.

#### Classification of Ground Modification Techniques

Four groups of ground improvement Techniques are distinguished:

1. Mechanical modification
2. Hydraulic modification

3. Physical and chemical modification
4. Modification by inclusion and Confinement.

### **1. Mechanical modification**

Soil density is increased by the application of

Short-term external mechanical forces, including Compaction of **surface layers** by:

- Static,
- Vibratory,
- Impact rollers,
- Plate vibrators.

**Deep compaction** by heavy tamping at the surface or vibration at depth.

Rollers are the construction equipment used for the compaction of soil, gravel, sand, crushed stone layers, etc. Roller working principle is based on vibration, impact loading, kneading and by applying direct pressure on the respective layer. The four most commonly used rollers are;

Vibratory Roller

Tamping roller/ sheep foot roller

Smooth wheel rollers

Pneumatic tired roller

Home > Construction Machinery > Rollers

Rollers Jalal Afsar July 3, 2012 Construction Machinery 1 Comment

Rollers are the construction equipment used for the compaction of soil, gravel, sand, crushed stone layers, etc. Roller working principle is based on vibration, impact loading, kneading and by applying direct pressure on the respective layer. The four most commonly used rollers are;



Vibratory Roller

Tamping roller/ sheep foot roller

Smooth wheel rollers

Pneumatic tired roller

## VIBRATORY ROLLER

Vibratory type rollers have two smooth wheels/ drums plus the vibrators. One is fixed at the front and the other one is on the rear side of vibratory roller. Both wheels/drums are of the same diameter, length and also of same weight. Vibratory roller covers the full area under wheel. To make vibratory roller more efficient, vibrators are also fixed with smooth wheel rollers. Vibration of vibrators arranges the particles by first disturbing even the arranged ones. On the other hand weight of wheels exerts direct pressure on the layer. Vibrators are turned off during the reversed motion of roller. In that time only static weight directly acts on the soil layer.

Vibration is to reduce the air voids and to cause densification of granular soils. During vibration of soil layer, rearrangement of particles occurs due to deformation of the granular soil because of oscillation of the roller in a cycle.



## SHEEP FOOT ROLLER/ TAMPING ROLLER

Sheep foot roller also named tamping roller. Front steel drum of sheep foot roller consists of many rectangular shaped boots of equal sizes fixed in a hexagonal pattern. Coverage area of sheep foot roller is less i.e., about 8- 12% because of the boots on drums. Sheep foot roller done compaction by static weight and kneading of respective layer. This makes tamping roller better suited for clay soils. Contact pressure of sheep foot roller varies from 1200- 7000Kpa.



Tamping foot roller consists of four wheels and on each wheel kneading boots/feet are fixed. Tamping roller has more coverage area i.e., about 40- 50%. Contact pressure of tamping roller varies from 1400 – 8500KPa. It is best dedicated for fine grained soils.



## SMOOTH WHEEL ROLLER

Smooth wheel roller and vibratory rollers are the same. Both have the same characteristics. Only the difference in both is vibratory equipment. Smooth wheel roller has no vibrator attached with the drum. This makes smooth wheel roller best suited for rolling of weaker aggregates, proof rolling of subgrades and in compacting asphalt pavements. Compaction of clay or sand is not a good choice to done with smooth wheel roller. This is so, because there are many empty voids in clay soil and sand, which cannot be minimized without vibrators.



## 2. Hydraulic modification

Free –pore water is forced out of the soil via (by means of) drains or wells.

- In coarse grained soils, this is achieved by lowering the ground water level through pumping from boreholes or trenches.
- In fine-grained soils, The long term application of external loads (preloading) or electrical forces (electrokinetic stabilization) is required.

## 3. Physical and chemical modification

Additives include: - natural soils - industrial by-products or waste materials (fly ash, slag), - Cementations and other chemicals (lime, cement) which react with each other and the ground.

When additives are injected via boreholes under pressure into the voids within the ground or between it and a structure, the process is called **GROUTING**. Rigs with multiple injectors deliver the stabilizing fluid into the soil. The fluid will prefer to travel into cracks and fissures.

Soil stabilization by heating the ground and by freezing the ground are **THERMAL METHODS OF MODIFICATION**.

- Heating evaporates water and causes **permanent changes** in the mineral structure of soils.
- Freezing solidifies part or all of the water and **bonds individual particles** together.

## 4. Modification by inclusion and Confinement Reinforcement by:

- Fibers,
- Strips
- Bars,
- Meshes and
- Fabrics.

Insitu reinforcement is achieved by nails and anchors.

### **Suitability, Feasibility, Desirability**

The choice of a method of ground improvement depends on many factors including:

- Type and degree of improvement required
- Type of soil, geological structure,

- Seepage conditions,

Cost (the size of the project may be Decisive),

- Availability of equipment and materials and the quantity of work required,
- Construction time available,
- Possible damage to adjacent structures or Pollution of ground water resources,
- Durability of the materials involved,
- Toxicity or corrosiveness of any chemical

Additives (government regulations may Restrict the choice of additives),

Reversibility or irreversibility of the process,

- Reusability of components,
- Reliability of methods of analysis and design,
- Feasibility of construction control and performance measurements.

The feasibility of a particular method is strongly Related to the type of problem in hand:

- a foundation,
- An embankment on soft ground,
- An unstable slope,
- An excavation,
- An earth-retaining structure,
- A leaking dam or reservoir.

Traditional Objectives and Emerging Trends The aim of improving soils as foundation or Construction materials:

1. Increase strength, reduce compressibility
2. Reduce distortion under stress (increase Stress-strain modulus)
3. Reduce compressibility
4. Control shrinking and swelling (improve volume stability)
5. Control permeability, reduce water pressure, redirect seepage
6. Prevent detrimental physical or chemical Changes due to environmental conditions

(Freezing/thawing, wetting/drying) \

7. Reduce susceptibility to liquefaction

8. Reduce natural variability of borrow

Materials or foundation soils.

### **Environmental Geotechnics**

Examples of desirable ground modification activities within the framework of environmental geotechnics are:

- Constructive use and if necessary modification of waste materials,
- Prevention of subsidence due to mining
- Preservation of quality and flow patterns of ground water.

#### Containment and Constructive use of Waste Materials

- Ground modification techniques are also increasingly being applied in the rehabilitation of hazardous-waste disposal areas.

- Of increasing concern to environmentally

conscious engineers is the constructive use of high-energy waste materials such as slag and fly ash. Part of this concern arises from the Estimated increase in ash production in the years to come. In the United States, it has been predicted that by next century coal burning will Produce 200 million tons of ash per year. Fly ash could be used as:

- Structural fill on its own or
- In combination with lime or cement

As a stabilizing agent for road bases.

### **Classification of Ground Improvement Techniques**

4 Groups of Ground Improvement techniques:

**Mechanical Modification:** Soil density is increased by the application of mechanical force, including compaction of surface layers by static vibratory such as compact roller and plate vibrators.

#### **Hydraulic Modification:**

1. Free pore water is forced out of soil via drains or wells.
2. Coarse grained soils; it is achieved by lowering the ground water level through pumping from boreholes, or trenches.
3. In fine grained soils the long term application of external loads (preloading) or electrical forces (electro osmotic stabilization)

**Physical and chemical modification:**

1. Stabilization by physical mixing adhesives with surface layers or columns of soil.
2. Adhesive includes natural soils industrial byproducts or waste. Materials or cementations or other chemicals which react with each other and/or the ground.
3. When adhesives are injected via boreholes under pressure into voids within the ground or between it and a structure the process is called grouting.
4. Soil stabilization by heating and by freezing the ground is considered thermal methods of modifications.

**Modification by inclusions and confinement:**

1. Reinforcement by fibers, strips bars meshes and fabrics imparts tensile strength to a constructed soil mass.
2. In-situ reinforcement is achieved by nails and anchors. Stable earth retaining structure can also be formed by confining soil with concrete, Steel, or fabric elements

## UNIT-2

### Deep Compaction Techniques

Densification of **deep soil deposits** is achieved by the following techniques:

- Blasting
- Vibratory probe
- Vibratory compactors

#### b. Blasting

In this technique a certain amount of explosive charge is buried at a certain depth of a cohesion less soil required to be compacted and is then detonated.

A pipe of 7.5 to 10 cm is driven to the required depth in the soil strata. The sticks of dynamite and an electric detonator are wrapped in the water proof bundles and, lowered through the casing as shown in Fig.

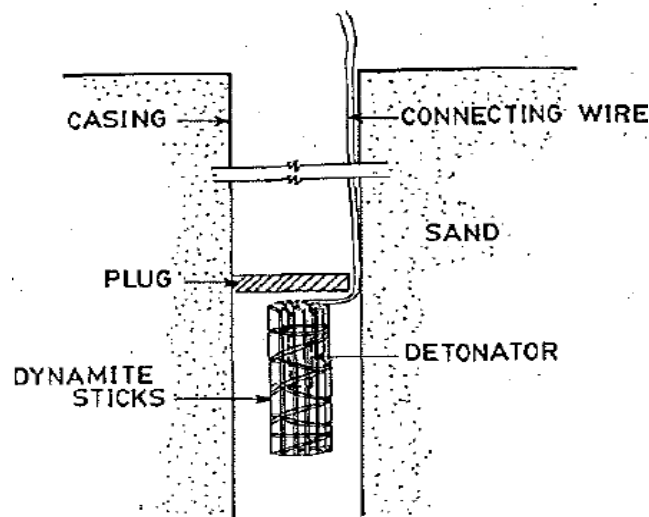

- The casing is withdrawn and a wad of paper or wood is placed against the charge of explosives to protect it from misfire.
- The hole is backfilled with sand in order to obtain the full force of the blast.
- The electrical circuit is closed to fire the charge.
- A series of holes are thus made ready.
- Each hole is detonated in succession and the resulting large diameter holes formed by lateral displacement are backfilled.
- The surface settlements, are measured by taking levels or from screw plates embedded at certain depth below the ground surface.



- Usually the explosives are arranged in the form of a horizontal grid.
- The spacing of the charges is decided by the depth of strata to be densified, the size of charge and the overlapping of the charges.
- A spacing of 3 to 8 m is typical and a spacing less than 3 m should be avoided
- Compaction is carried out in a single tier only if the depth of stratum to be densified is 10m or less.
- In such a case the depth of explosive charge should be below half the depth of the mass or stratum to be densified (approximately at  $2/3$  point).
- More than one tier should be planned, if the depth of stratum to be densified is more than 10m. Generally the depth of charge should be greater than the radius of sphere of influence (R).
- Successive blasts of small charges at appropriate spacings are likely to be more effective than a single large blast.
- Theoretically, one charge densifies the surrounding adjacent soil and the soil beneath the blast.
- Charges should be timed to explode such that the bottom of the layer being densified upwards in a uniform manner.
- The uppermost portion of the stratum may be less densified which may be compacted by vibratory rollers.
- The amount of charge to be used should be optimal such that it is just enough to shatter the soil mass uniformly but not to create permanent surface craters.
- A carefully placed charge with required amount and depth shall not create a surface heave more than 0.15 m.

### **Disadvantages of Blasting Technique**

- Although blasting is one of the most economical ground improvement techniques, it suffers the disadvantages of non-uniformity, potential adverse effects on adjacent structures and the danger associated with the use of explosives in populated areas.
- Very fine grained soils which have high cohesive forces cannot be compacted by this method.
- Maximum compaction is obtained only when the soil is dry or completely saturated.

- In case of any loose sand, good results are obtained due to free fall of small size particles into the voids between the soil grains thus making a dense soil.
- But in partially saturated soils due to capillary tension between the soil grains, less densification is achieved.
- Theoretically there is no limit for the depth of densification by this technique.
- However, if the depth is more than 10 m, compaction should be done in more than one tier for which a careful planning is needed to achieve the result.
- Thus it is emphasized that adequate data with regard to type of soil, degree of saturation, depth of deposit to be densified and degree of densification required should be collected.
- A preliminary test may be necessary to ascertain the spacing, depth, amount of charge and sequence of operation.

## **DEEP VIBRO TECHNIQUES**

- Usually the soil conditions are described in a soil investigation report.
- If the properties of the existing soil cannot fulfil the requirements set by the proposed loading conditions, deep vibro techniques offer an economical solution for the ground improvement.
- They can be carried out to almost any depth.
- Deep Vibro techniques present flexible solutions for soil improvement.
- They are mainly used under foundations of structures that are to be constructed on soils of low bearing capacity.



## DYNAMIC COMPACTION

Technique involves repeatedly dropping a large weight from a crane

- Weight may range from 6 to 172 tons
- Drop height typically varies from 10 m to 40 m

Degree of densification achieved is a function of the energy input (weight and drop height) as well as the saturation level, fines content and permeability of the material

- 6 – 30 ton weight can densify the loose sands to a depth of 3 m to 12 m



Done systematically in a rectangular or triangular pattern in phases

- Each phase can have no of passes; primary, secondary, tertiary, etc.
- Spacing between impact points depend upon:
  - Depth of compressible layer
  - Permeability of soil
  - Location of ground water level
- Deeper layers are compacted at wider grid spacing, upper layers are compacted with closer grid spacing
- Deep craters are formed by tamping
- Craters may be filled with sand after each pass
- Heave around craters is generally small

## DYNAMIC REPLACEMENT

- The formation by heavy tamping of large pillars of imported granular soil within the body of soft saturated soil to be improved
- The original soil is highly compressed and consolidated between the pillars and the excess pore pressure generated requires several hours to dissipate
- The pillars are used both for soil reinforcement and drainage

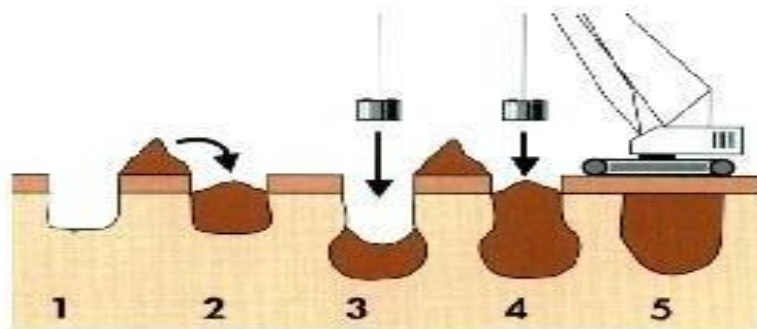

Process of Dynamic Replacement

## ROTATIONAL DYNAMIC COMPACTION

- A new dynamic compaction technique which makes use of the free fall energy as well as rotational energy of the tamper called Rotational Dynamic Compaction (RDC)
- The technique increases depth of improvement in granular soils
- Comparative study showed that the cone penetration resistance was generally larger than conventional dynamic compaction and the tamper penetration in rotational dynamic compaction was twice as large as that of conventional dynamic compaction

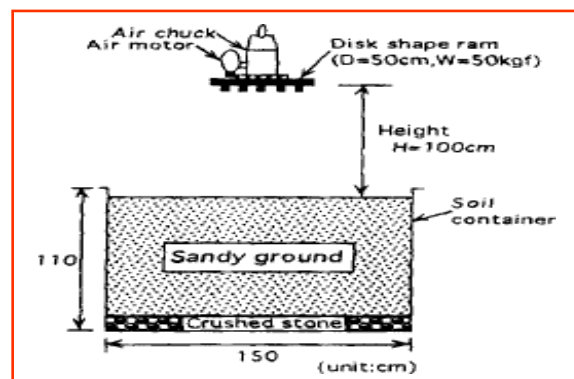

## APPLICATIONS OF DYNAMIC COMPACTION

- Reduce foundation settlements
- Densify waste deposits
- Prevent soil liquefaction during earthquakes
- Increase in-situ density of land reclamation fills

## SUITABILITY OF DYNAMIC COMPACTION

Soil Type	Effectiveness	When to get expert advice
Sands with < 5% fines	excellent	Grain size curve very steep, High carbonate or Mica content
Sands with < 12 % fines	Marginal to good	Success depends on many factors, such as clay content, grain shape, grain size curve, water table.
Silt	Poor to marginal	Always ask for advice if DC shall work in silt Method may occasionally work in combination with other systems -> Wick drains
Clay	Not applicable	
Land reclamation	Excellent, if spec for fill material is appropriate	Get advice at early stage to influence already the spec for the fill material.

## INSTALLATION PROCESS

The weight is dropped in a primary, secondary and often also tertiary grid. The primary grid (widest spacing) is used to achieve compaction at depth. It uses the largest weight and highest drop. The compaction effect at depth is larger as long as the soil surface is not yet densified. The uncompacted soil produces less dispersion of the impact wave. The secondary and tertiary grid are used to achieve compaction at medium and shallow depth. Sometimes a so called “ironing path” with a smaller weight and lower drop height concludes the process. This ironing path can be replaced by roller compaction.

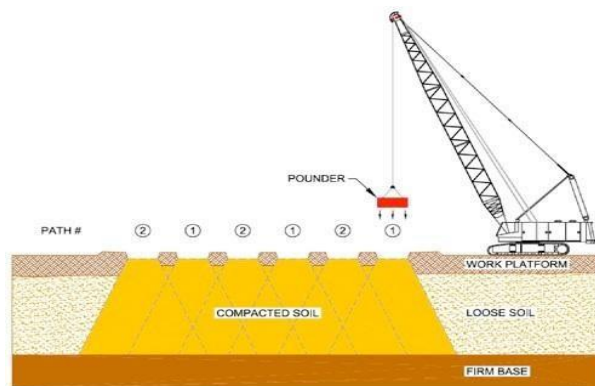

## VIBROCOMPACTION

Compaction of granular soils by depth vibrators is known as Vibro Compaction. The method is also known as “Vibroflotation”. Natural deposits as well as artificially reclaimed sands can be compacted to a depth of up to 70 m. The intensity of compaction can be varied to meet bearing capacity criteria. Other improvement effects such as reduction of both total and differential settlements are achieved. The risk of liquefaction in a earthquake prone area is also drastically reduced.

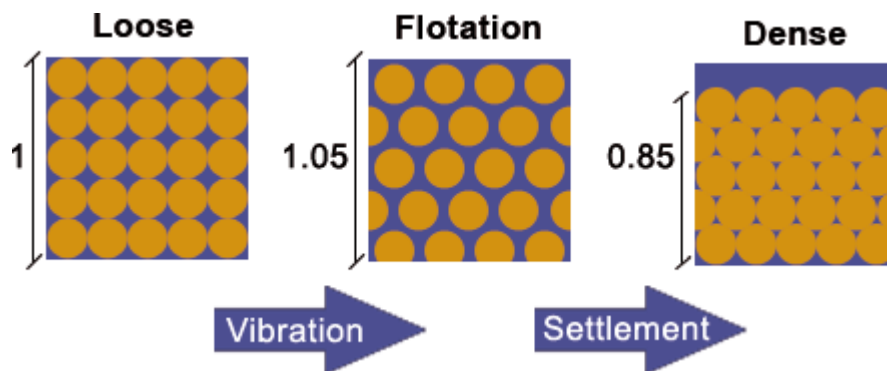

### The principle of sand compaction (Vibroflotation):

The compaction process consists of a flotation of the soil particles as a result of vibration, which then allows for a rearrangement of the particles into a denser state.

### Effects of Compaction

- The sand and gravel particles rearrange into a denser state.
- The ratio of horizontal to vertical effective stress is increased significantly.
- The permeability of the soil is reduced 2 to 10 fold, depending on many factors.
- The friction angle typically increases by up to 8 degrees.
- Enforced settlements of the compacted soil mass are in the range of 2 % to 15 %, typically 5 %
- The stiffness modulus can be increased 2 to 4 fold.

### Test Pattern

On large projects the optimal compaction grid spacing has to be determined by test grids.

The compaction effect in the test grids should be as close as possible to the treatment in the later production areas.

In order to achieve this it is advisable to arrange the test grids close to each other.

The distance between grid A (3.10 m) and grid B (3.40 m) should be

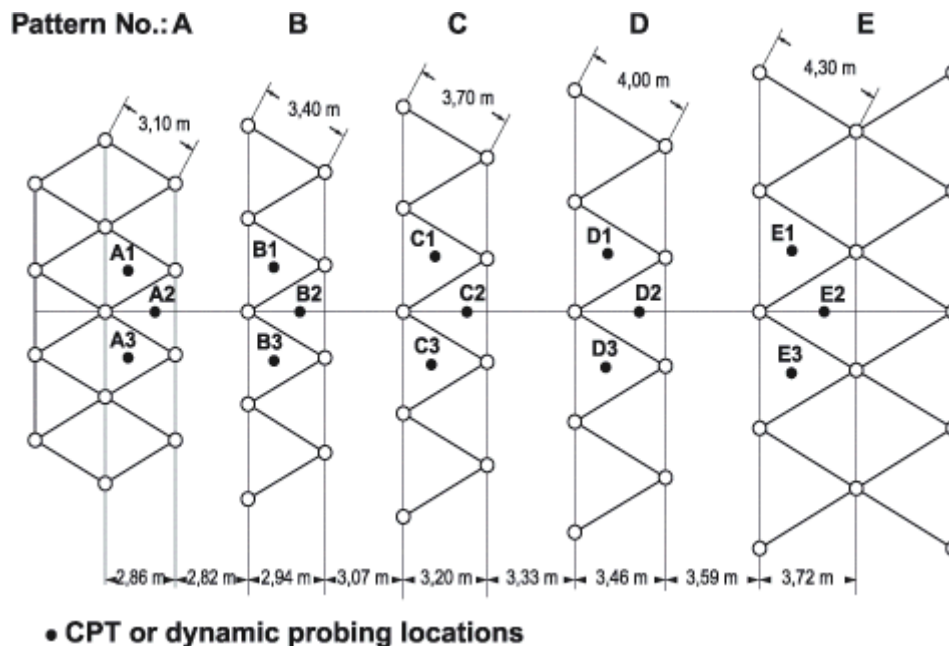

## DYNAMIC TAMPING

A tamping machine or ballast tamper is a machine used to pack (or tamp) the track ballast under railway tracks to make the tracks more durable. Prior to the introduction of mechanical tampers, this task was done by manual labour with the help of beaters. As well as being faster, more accurate, more efficient and less labour-intensive, tamping machines are essential for the use of concrete sleepers since they are too heavy (usually over 250 kg (551 lb)) to be packed into the ballast by hand.

Early machines only lifted the track and packed the ballast. More modern machines, sometimes known as a tamper-liner or tamping and lining machine, also correct the alignment of the rails to make them parallel and level, in order to achieve a more comfortable ride for passengers and freight and to reduce the mechanical strain applied to the rails by passing trains. This is done by

finding places where the sleepers have sunk from the weight of the passing trains or frost action, causing the track to sag. The tamper lifts each sleeper and the rails up, and packs ballast underneath. When the sleeper is laid down again, the sagged rails now sit at the proper level. In cases where frost action has caused adjacent rails to rise higher, ballast tampers can raise rails above their original level to make the line level again. "Lining" rails doesn't involve ballast tamping, it merely ensures the rails are perfectly parallel and straight as possible. Combining tamping and lining into a single machine saves time and money, as only one machine needs to be run over the track to perform both functions.

## **COMPACTION PILES**

*Sand* compaction piling (SCP) is a cost-effective method of ground improvement which is commonly used to improve soft seabed soils prior to land reclamation works. This method involves driving closely-spaced sand columns into the soft seabed to form a grid of sand columns, which imparts higher strength and stiffness to the improved ground. The installation of these sand compaction piles often involves a large amount of cavity expansion displacement of the soft clay around the sand piles, which in turn, leads to significant changes in the strength and stiffness of the soft clay around the sand piles. In practice and research, the properties of the soft clay are taken to be those of the in-situ soil.

***The improvement in the strength of the softy clay is around 25% to 50%.***

The results of these experiments allow the changes in total stress and pore pressure due to the installation of sand compaction piles to be quantified. Comparison of the measured changes in lateral stress and pore pressure with conventional plane strain cavity expansion theory shows that the latter gives a reasonably good estimate at large depth for the entire installation process. However, deviation from plane strain cavity expansion theory was noted at shallow depths. To account for the effect of the ground surface, a semi-empirical plane stress cavity expansion theory was proposed for the shallow zones. The establishment of the two limits formed by the plane strain and plane stress theories allows semi-empirical relations to be fitted to the data. These findings also indicated that, in order to mobilize significant set-up of stress in the improved ground, there must be substantial further cavity expansion during the sand injection



stage of SCP. The cumulative total stress and pore pressure increment at a given location due to the installation of multiple piles in a grid is also reasonably estimated by superimposing the increments due to the installation of each pile. The measured and computed undrained shear strength after the dissipation of the excess pore pressure is also higher in the clays enclosed within the SCPs. The quantum of improvement in the strength of the soft clay due to the cavity expansion displacement is typically of the order of 25% to 50%.

Tests were also conducted to quantify the relative performance of different methods of installing sand piles. The results of this comparative study show that the effects of cavity expansion displacement in the soft clay do lead to a significant improvement in the strength and stiffness of the soft clay. The sequence of installation also affects the resulting properties of the soft clay, although this is second-order compared to the effect of installation method.

Some of the results of this study have been published in international journals and conferences. The significance of the published results was recently highlighted by a detailed citation of the team's research by Professor Osamu Kusakabe in a keynote address in the International Conference on Physical Modelling in Geotechnics, in Newfoundland, Canada.

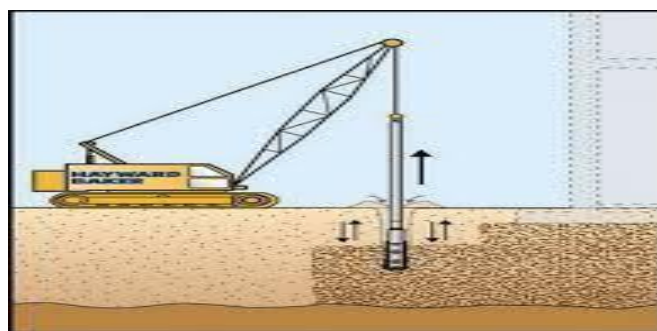
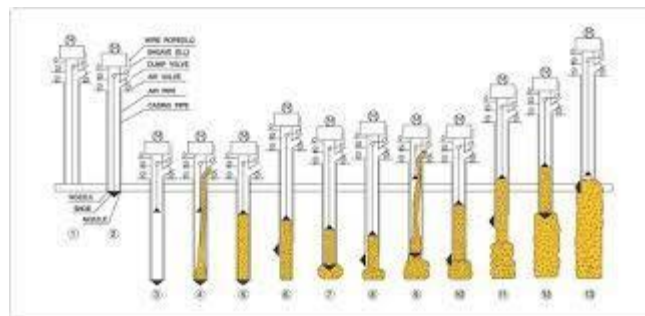

## **VIBRO REPLACEMENT**

Where fines content of the soils in the target treatment interval exceeds the acceptable range for vibro compaction, another ground improvement process of Vibro-Replacement/Displacement by installation of stone columns can be applied.

### **Type of soil**

- Vibro Replacement is an accepted method for subsoil improvement, at which large-sized columns of coarse backfill material are installed in the soil by means of special depth vibrators.
- Vibro replacement is part of the deep vibratory compaction techniques whereby loose or soft soil is improved for building purposes by means of special depth vibrators.
- Contrary to vibro compaction which densifies non-cohesive soil by the aid of vibrations and improves it thereby directly, vibro replacement improves non compactable cohesive soil by the installation of load bearing columns of well compacted, coarse grained backfill material.

### **Equipment and execution**

- For the construction of Vibro Replacement columns the bottom feed process is frequently employed, which feeds coarse granular material to the tip of the vibrator with the aid of pressurized air.
- To optimize the performance of this process and to accommodate the specialized equipment, vibrocat is developed at base unit which guides the vibrator on its leader and allows the exertion of an additional pull-down pressure during penetration and compaction.
- The Vibro Replacement process consists of alternating steps.
- During the retraction (pull away) step, gravel runs from the vibrator tip into the annular space created and is then compacted and pressed into the surrounding soil during the following re-penetration step.

- In this manner stone columns are created from the bottom up, which act as a composite with the surrounding soil under load.



### **Vibro-Replacement Procedures**

**Stage1:** The vibrocat positions the vibrator over the required location of the compaction point and stabilises itself using hydraulic supports. A wheel loader fills the skip with aggregate.

The jet at the bottom of the Vibroflot is turned on and lowered into the ground

**Stage2:** The water jet creates a quick condition in the soil. It allows the vibrating unit to sink into the ground

## **UNIT-3**

### **Hydraulic Modifications**

Dewatering or construction dewatering are terms used to describe the action of removing groundwater or surface water from a construction site. Normally dewatering process is done by pumping or evaporation and is usually done before excavation for footings or to lower water table that might be causing problems during excavations. Dewatering can also be known as the process of removing water from soil by wet classification.

#### **PURPOSES FOR DEWATERING**

- For construction excavations or permanent structures that are below the water table and are not waterproof or are waterproof but are not designed to resist the hydrostatic pressure
- Permanent dewatering systems are far less commonly used than temporary or construction dewatering systems
- To provide suitable working surface of the bottom of the excavation.
- To stabilize the banks of the excavation thus avoiding the hazards of slides and sloughing.
- To prevent disturbance of the soil at the bottom of excavation caused by boils or piping. Such disturbances may reduce the bearing power of the soil.
- Lowering the water table can also be utilized to increase the effective weight of the soil and consolidate the soil layers. Reducing lateral loads on sheeting and bracing is another way of use.

#### **VARIOUS METHODS OF DEWATERING**

- Surface water control like ditches, training walls, embankments. Simple methods of diverting surface water, open excavations.
- Simple pumping equipment. Gravity drainage. Relatively impermeable soils. Open excavations especially on sloping sites. Simple pumping equipment.
- Sump pumping
- WellPoint systems with suction pumps.
- Shallow (bored) wells with pumps.
- Deep (bored) wells with pumps.

- Educator system
- Drainage galleries. Removal of large quantities of water for dam abutments, cut-offs, landslides etc. Large quantities of water can be drained into gallery (small diameter tunnel) and disposed of by conventional large – scale pumps.
- Electro-osmosis. Used in low permeability soils (silts, silty clays, some peats) when no other method is suitable. Direct current electricity is applied from anodes (steel rods) to cathodes (well-points, i.e. small diameter filter wells)

## **ADVANTAGES AND DISADVANTAGES**

### **ADVANTAGES**

- Reduces the amount of sediment leaving the site
- Allows for a more in-depth site assessment – additional necessary erosion control measures may be identified

### **DISADVANTAGES**

- Must abide by multiple government laws and standards and obtain appropriate permits
- Requires frequent maintenance
- May be costly

### **Sumps and sump pumping:**

A sump is merely a hole in the ground from which water is being pumped for the purpose of removing water from the adjoining area (Fig 9.1). They are used with ditches leading to them in large excavations. Up to maximum of 8m below pump installation level; for greater depths a submersible pump is required. Shallow slopes may be required for unsupported excavations in silts and fine sands. Gravels and coarse sands are more suitable. Fines may be easily removed from ground and soils containing large percent of fines are not suitable. If there are existing foundations in the vicinity pumping may cause settlement of these foundations. Subsidence of adjacent ground and sloughing of the lower part of a slope (sloped pits) may occur. The sump should be preferably lined with a filter material which has grain size gradations in compatible with the filter rules. For prolonged pumping the sump should be prepared by first driving sheeting around the sump area for the full depth of the sump and installing a cage inside the sump made of wire mesh with internal strutting or a perforating pipe filling the filter material in

the space outside the cage and at the bottom of the cage and withdrawing the sheeting. Two simple

The essential feature of this method is a sump below the ground level of the excavation at one or more corners or sides.. a small ditch is cut around the bottom of the excavation , falling towards the sump. It is the most widely used and economical of all methods of ground water lowering. This method is also more appropriate in situations where boulders or other massive obstructions are met with the ground. There is also a disadvantage that the groundwater flows towards the excavation with a high head or a steep slope and hence there is a risk of collapse of the sides.

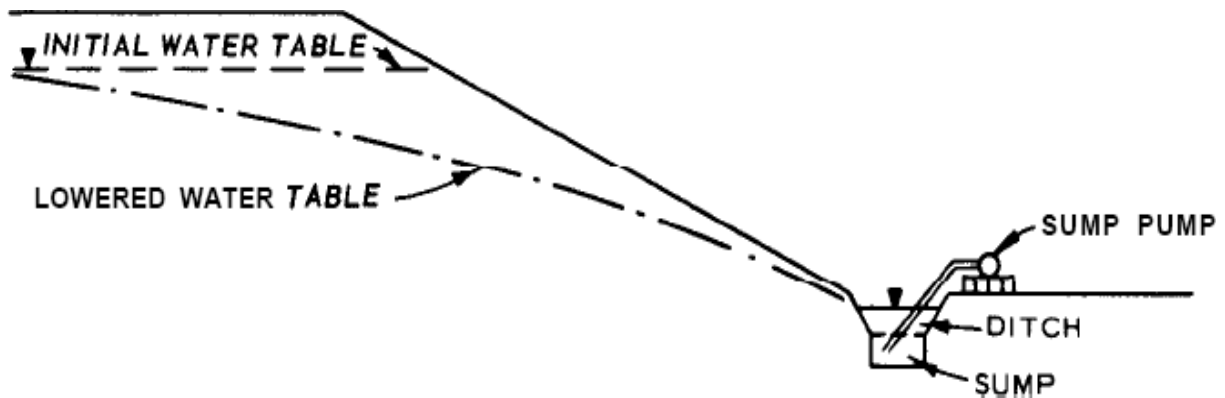

### Single Stage Well Point

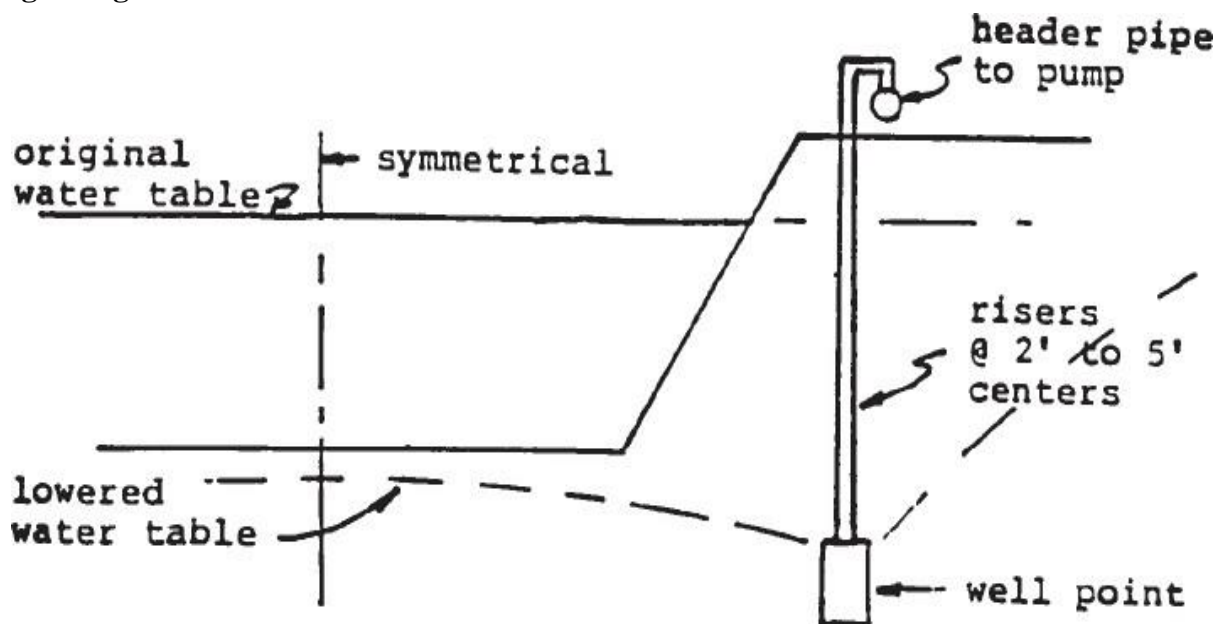

## Applicability of Dewatering Systems

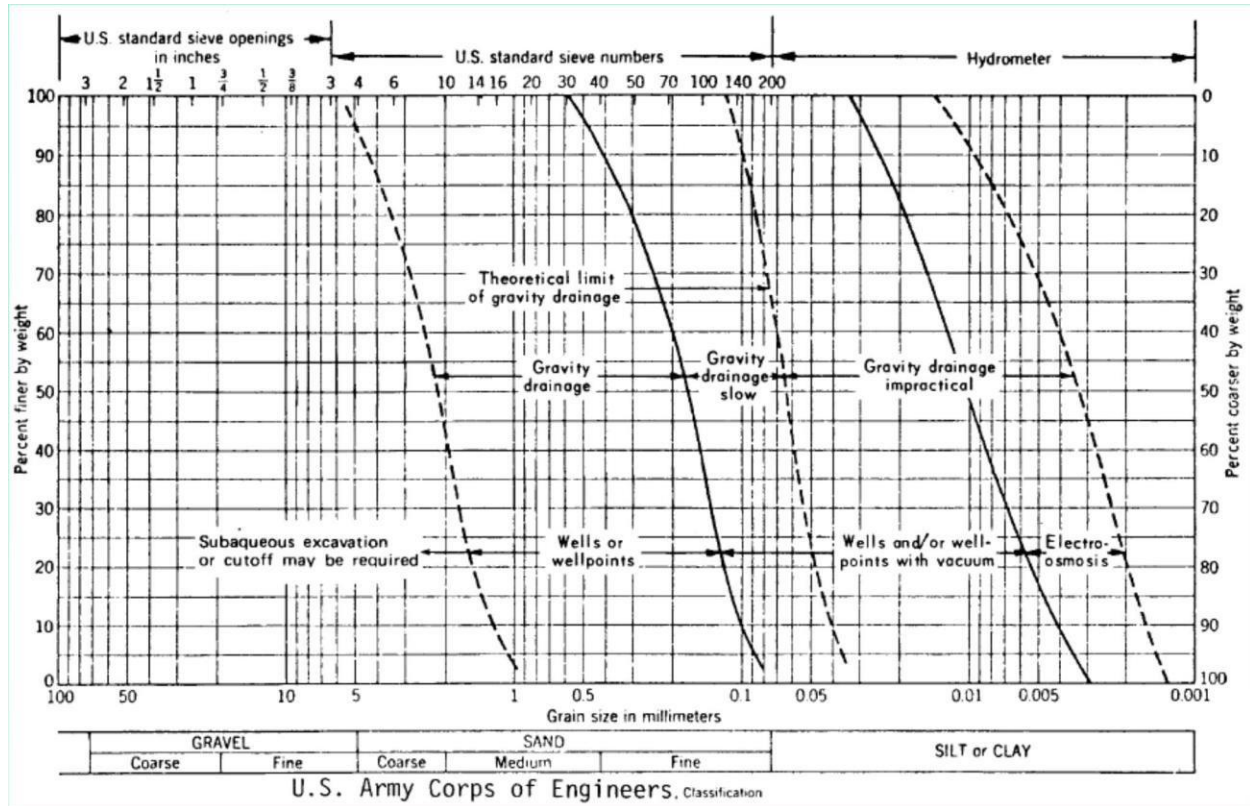

## Settlement of Adjacent Structures

$$\delta = \frac{H}{1 + e_0} C_c \log \frac{\sigma'_{vo} + \Delta\sigma}{\sigma'_{vo}}$$

$$\Delta\sigma = \Delta h \gamma_w$$

$\Delta h$  = reduction of groundwater level

Cut off walls/trenches are used to prevent the damage.

## Design Input Parameters

Most important input parameters for selecting and designing a dewatering system:

- The height of the groundwater above the base of the excavation
- The permeability of the ground surrounding the excavation

## Dupuit-Thiem Approximation for Single Well

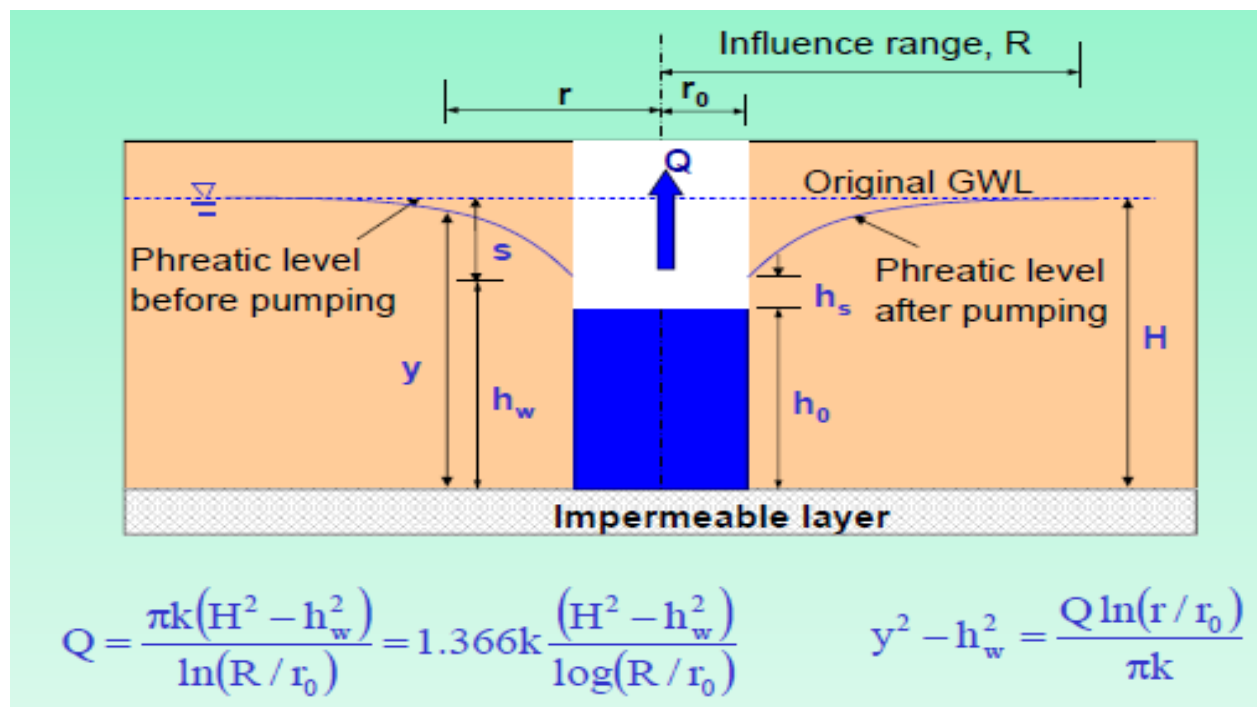

## Height of Free Discharge Surface

$$h_s = \frac{C(H - h_0)}{H}$$

Ollos proposed a value of  $C = 0.5$



## Influence Range

$$L = C''(H - h_w)\sqrt{k}$$

Sichardt (1928)  $C = 3000$  for wells or 1500 to 2000 for single line well points  
 $H, h_w$  in meters and  $k$  in m/s

## Forchheimer Equation for Multiwells

Forchheimer (1930)

$$Q = \frac{\pi k (H^2 - y^2)}{\ln L - (1/n) \ln x_1 x_2 \dots x_n}$$

## Circular arrangement of wells

$$Q = \frac{\pi k (H^2 - y^2)}{\ln L - \ln a}$$

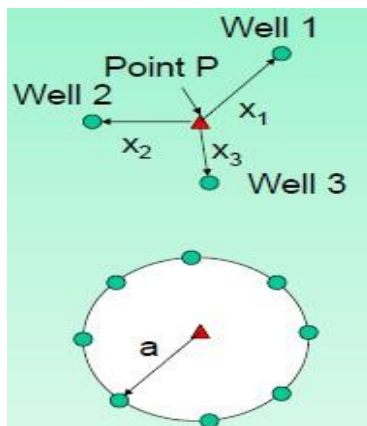

## Spacing of Deep Wells

- Obtain an estimate of the total quantity of water to be pumped from Eq.1. The values of  $H$ ,  $y$  and  $R$  are determined by the type of aquifer, the required draw down and soil type. If  $a$  is the radius of the equivalent circular area and  $X$  and  $Y$  are the dimensions of the excavation,

$$a = \frac{Sq(XY)}{3.14}$$

- The number of wells is obtained by dividing the total yield with that of yield of a single well.

Example: 1 A building has to be constructed on ground which has the following ground conditions: Dimensions of the building=30m x 20m and the depth of excavation is 10m (water table is at ground level) Permeability of sand deposits below ground level =  $10^{-3}$  m/s.

The depth of water level has to be decreased by 2m below excavation level. In order to construct the building, dewatering has to be done by laying pumps at various junctions. Calculate the rate of flow of water when one pump is laid and compare it with the discharge when the number of pumps is increased. The site conditions of the building is shown in figure (1).

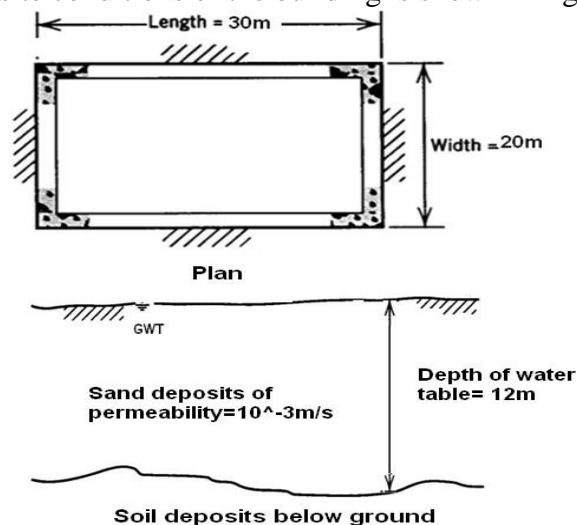

Solution:

From the given data we know:  
Permeability of the sand,  $k = 10^{-3}$  m/s  
Depth of water level,  $h = 12$  m  
Depth of drawdown = 2 m

In most of the cases, there is an empirical relationship to obtain an approximate value for the line of influence,  $L(=R)$  and this is given by Sichardt:

The value of constant C in meters when k is in meters /second are:

C= 3000 for wells

=1500 to 2000 for single line wells (Mansur and Kaufmann)

Consider C=3000

Hence,  $L= 3000*2*(10^{-3})^{0.5} = 189.73\text{m}$

The formula for discharge is given by Forchheimer is:

$$Q = \frac{\pi k (H^2 - y^2)}{\ln L - \ln a}$$

Here H= 12m, y=10m, L =189.73 and a= 7.8m

$$Q = \frac{\pi k (12^2 - 10^2)}{\ln 189.73 - \ln 7.8}$$

= 0.0433 m<sup>3</sup>/s

Expression for yield from a single well is given by

$$Q_{max} = 2\pi r h_0 \frac{\sqrt{k}}{15}$$

Substituting r = 0.1m,  $h_0 = 2\text{m}$  and  $k = 10^{-3} \text{ m/s}$ , the yield for a single well is obtained as 0.01 m<sup>3</sup>/s. Hence, the number of wells can be taken as 5 to cater to the discharge of = 0.0433 m<sup>3</sup>/s.

If the number of pumps are increased to more than one, the formula given by Forchheimer is:

$$Q = \frac{\pi k (h^2 - y^2)}{\ln L - \frac{1}{n} \ln x_1 x_2 x_3 \dots x_n}$$

Consider five pumps at different locations in and around the building at 10m respectively in different directions. Now n=5,  $x_1=10\text{m}$ ,  $x_2=10\text{m}$ ,  $x_3=10\text{m}$ ,  $x_4=10\text{m}$  and  $x_5=10\text{m}$

$$Q = \frac{\pi * 10^{-3} * (12^2 - 10^2)}{\ln 189.73 - \frac{1}{4} \ln (10^5)} = 0.058 \text{m}^3/\text{s}$$

Hence five number of pumps will be able to cater to the discharge with adequate margin of safety.

Dewatering techniques need considerable practical experience and many of the terms and parameters in the formula have uncertainties and variability. Hence trials are useful to confirm if the design is going to work in a satisfactory manner.

### Dewatering by electro – osmosis

When an external electro motive force is applied across a solid liquid interface the movable diffuse double layer is displaced tangentially with respect to the fixed layer . this is electro osmosis. As the surface of fine grained soil particles causes negative charge, the positive ions in solution are attracted towards the soil particles and concentrate near the surfaces. Upon application of the electro motive force between two electrodes in a soil medium the positive ions adjacent to the soil particles and the water molecules attached to the ions are attracted to the cathode and are repelled by the anode. The free water in the interior of the void spaces is carried along to the cathode by viscous flow. By making the cathode a well, water can be collected in the well and then pumped out.

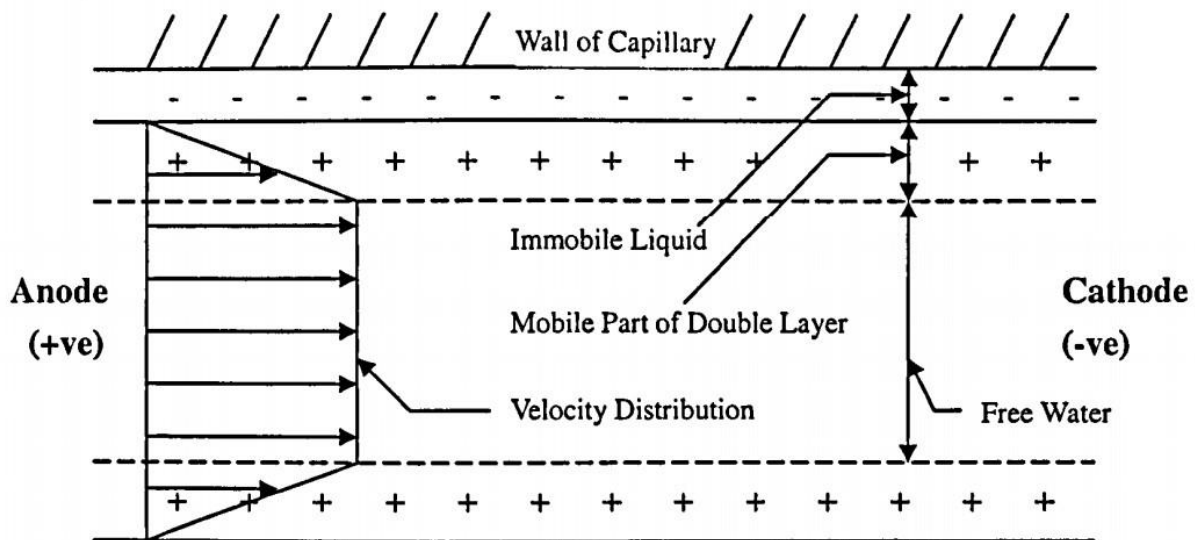

## INTRODUCTION

Electro osmotic consolidation means the consolidation of soft clays by the application of electric current. It was studied and applied for the first time by Casagrande. It is inherent that fine grained clay particles with large interfacial surface will consolidate and generate significant settlement when loaded. The settlement creates problem in the foundation engineering. Electro osmosis was originally developed as a means of dewatering fine grained soils for the consolidation and strengthening of soft saturated clayey soils. Electro osmotic dewatering essentially involves applying a small electric potential across the sediment layer. It is the process where in positively charged ions move from anode to cathode. ie. Water moves from anode to cathode where it can be collected and pumped out of soil Electro osmotic flow depends on soil nature, water content, pH and on ionic type concentration in the pore water.

**ELECTRO OSMOTIC CONSOLIDATION** Due to the applied electric potential the electrolysis of water occurs at the electrodes  $2\text{H}_2\text{O} \rightarrow \text{O}_2 (\text{g}) + 4\text{H}^+ + 4\text{e}^-$  oxidation (anode)  $4\text{H}_2\text{O} + 4\text{e}^- \rightarrow 2\text{H}_2 (\text{g}) + 4\text{OH}^-$  reduction (cathode) The clay particles have a  $\ominus$  charge. These above charge produce an electro static surface property known as the double layer which creates a net abundance of captions

Due to the applied electric potential the electrolysis of water occurs at the electrodes  $2\text{H}_2\text{O} \rightarrow \text{O}_2 (\text{g}) + 4\text{H}^+ + 4\text{e}^-$  oxidation (anode)  $4\text{H}_2\text{O} + 4\text{e}^- \rightarrow 2\text{H}_2 (\text{g}) + 4\text{OH}^-$  reduction (cathode) The clay particles have a above charge. These above charge produce an electro static surface property known as the double layer which creates a net abundance of captions.

in pore space. Electro osmotic transfer of water through clay is a result of diffuse double layer captions in the clay pores being attracted to a negatively charged electrode or cathode. When electrodes are placed across saturated clay mass and direct current is applied, water in the clay pore space is transported towards cathode by electro osmosis. In addition frictional drag is created by the motion of ions as they move through the clay pores helping to transport additional water. The flow generated by the electric gradient is called electro osmotic flow.

**EVALUATION OF ELECTRO OSMOTIC CONSOLIDATION** Determination of parameters Electrical operation systems for field application Materials Spacing between electrodes Cost of electrodes and installation cost.

## **DESIGN OF SUB-SURFACE DRAINAGE SYSTEMS**

Sub-surface drainage is the removal of excess groundwater below the soil surface. It aims at increasing the rate at which water will drain from the soil, and so lowering the water table, thus increasing the depth of drier soil above the water table. Sub-surface drainage can be done by open ditches or buried drains.

### **Sub-Surface Drainage Using Ditches**

Ditches have lower initial cost than buried drains; there is ease of inspection and ditches are applicable in some organic soils where drains are unsuitable. Ditches, however, reduce the land available for cropping and require more maintenance than drains due to weed growth and erosion.

### **Sub-Surface Drains Using Buried**

Drains Sub-Surface Drainage Using Buried Drains Buried drains refer to any type of buried conduits having open joints or perforations, which collect and convey drainage water.

They can be fabricated from clay, concrete, corrugated plastic tubes or any other suitable material. The drains can be arranged in a parallel, herringbone, double main or random fashion.

Sub-Surface Drainage Designs The Major Considerations in Sub-surface Drainage Design Include: Drainage Coefficient; Drain Depth and Spacing; Drain Diameters and Gradient;

Drainage Filters. Drainage Coefficient This is the rate of water removal used in drainage design to obtain the desired protection of crops from excess surface or sub-surface water and can be expressed in mm/day , m/day etc.

Drainage is different in Rain-Fed Areas and Irrigated Areas

### **Electrokinetic Stabilisation – Chief Mechanism**

1. From studies of clay mineralogy it is known that clays are made up of small particles (<0.002 mm) with a very large surface area in comparison to their mass.
2. The properties of a clay are therefore greatly influenced by the surface forces. These surfaces are negatively charged, primarily as a result of the isomorphism substitution of aluminium or silicon atoms by lower valency atoms.

3. This negative charge attracts (dipolar) water molecules, resulting in the clay particles being surrounded by layers of water, known as diffuse water layers (or diffuse double layers). The concentration of cations available in the pore water and the surface charge of the clay particle together control the thickness of this layer.
4. In addition, the pH of the system can influence the negative charge of the clay particles, in some cases (e.g. kaolinite) significantly, and therefore directly influence the thickness of the diffuse water layer.
5. The cations commonly found in the diffuse water layer and the pore water are variously sodium, potassium, calcium, magnesium and lithium, and in some cases higher order ions are also present (Little, 1987).
6. When cations of a higher valency and/or a larger ionic radius, such as calcium, silicon or aluminum, are introduced in significant concentrations, they saturate the solution and become adsorbed at the clay surface in preference to those ions originally present.
7. The result of this cation exchange, due for example to the classic case of lime (and hence calcium ion) addition, is a considerable reduction in the thickness of the diffused water layer, as illustrated in Fig. 3.
8. This allows closer contact between the clay platelets, which promotes edge-to-face attraction, or flocculation, and results in changes in the soil's workability, permeability, plasticity and swell properties.
9. Alteration of the soil pH results in changes in the solubility of the clay minerals present.
10. The reaction products such as amorphous calcium aluminates hydrate and calcium silicate hydrate gels, crystallizes with time to form a strong, brittle solid. This process is termed stabilization.

### **Preloading and Vertical Drains**

When highly compressible, normally consolidated clayey soil layers lie at limited/large depths, large consolidation settlements are expected as the result of the loads from large buildings, highway embankments, or earth dams etc. Pre-compression and provision of vertical drains in soft soil may be used to minimize post construction settlement.

This approach has resulted in a number of techniques involving

- Pre-compression or Pre-loading
- Sand drains

- Pre-fabricated Vertical Drains
- Vacuum consolidation
- High Vacuum Densification Method (HVDM)

**Preloading**

- Increases the bearing capacity
- Reduces the compressibility of weak ground

Achieved by placing temporary surcharge on the ground. Surcharge generally more than the expected bearing capacity.

In cohesion less soil and gravel -> lowering water table

Most effective -> soft cohesive ground.

**PRELOADING AND VERTICAL DRAINS**

- The process may be speed up by vertical sand drains.
- Vertical drains are installed in order to accelerate settlement and gain in strength of soft cohesive soil.
- Vertical drains accelerate primary consolidation only.
- As significant water movement is associated with it. Secondary consolidation causes only very small amount of water to drain from soil;
- Secondary settlement is not speeded up by vertical drains.
- Only relatively impermeable soil with benefit from vertical drains.
- Soils which are more permeable will consolidate under surcharge.
- Vertical drains are effective where a clay deposit contain many horizontal sand or silt lenses.

Preloading	Vertical
Reduce total and differential settlement	Speed up to settlement process
Economy in foundation system	Do not reduce the amount of deformation under a given load



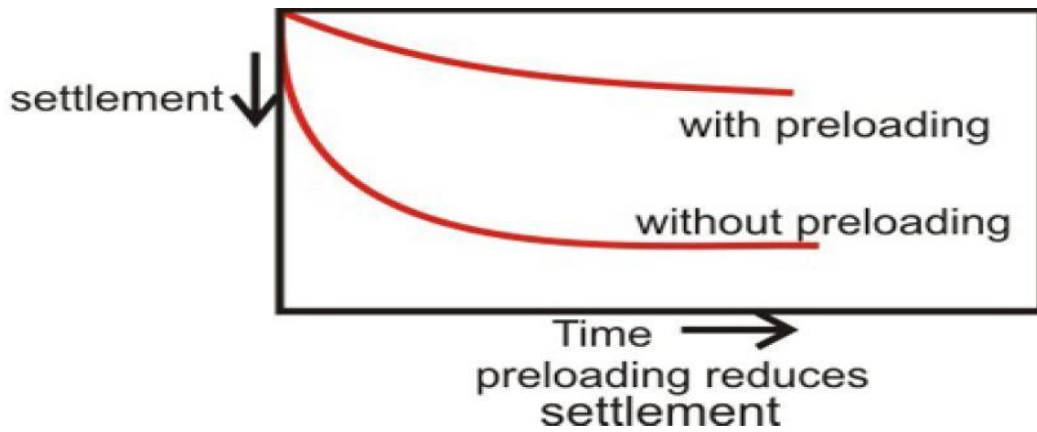

- Pre loading allows cheaper spread footings.
- Pre loading allows savings on foundation costs.

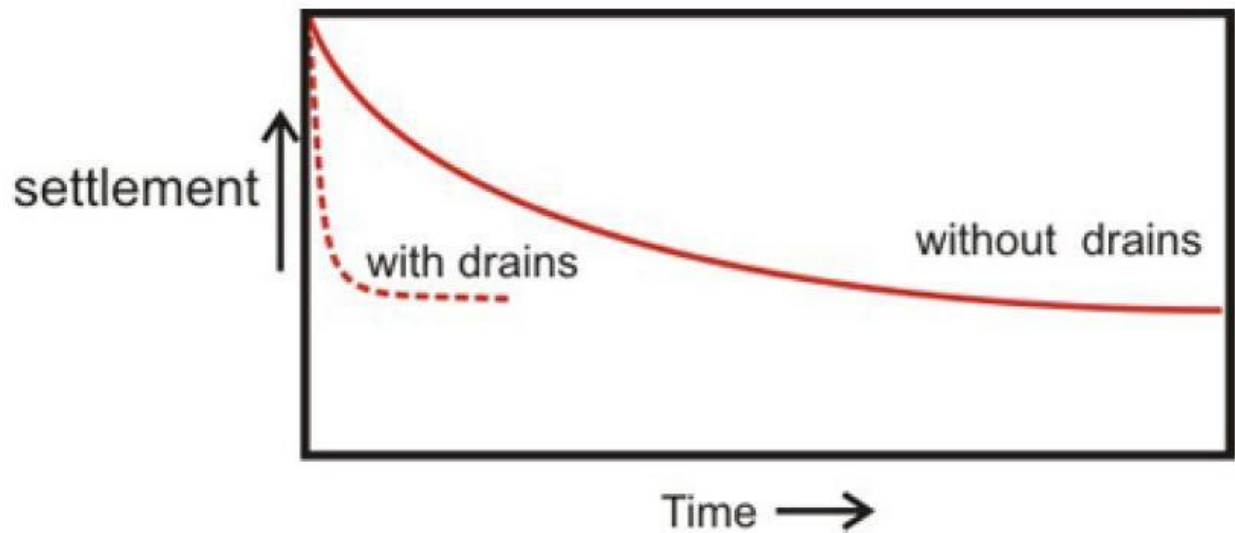

- Vertical drains accelerate settlements and do not reduce final movements

## GEOSYNTHESIS

Geosynthetics are artificial fibres used in conjunction with soil or rock as an integral part of a man made project

They are mainly grouped into two categories

- Geotextiles – permeable
- Geomembrane – impermeable

## VARIOUS TYPES OF GEOSYNTHESIS

- Geonets
- Geomats
- Geosynthetic clay liners
- Geofoam
- Geocells
- Geocomposites
- Geotextiles
- Geogrids
- Geomembranes

### Letter Symbols for Different Functions of Geosynthetics

- B** Barrier (fluid)
- D** Drainage
- E** Surficial Erosion Control
- F** Filtration
- P** Protection (of geomembranes)
- R** Reinforcement
- S** Separation

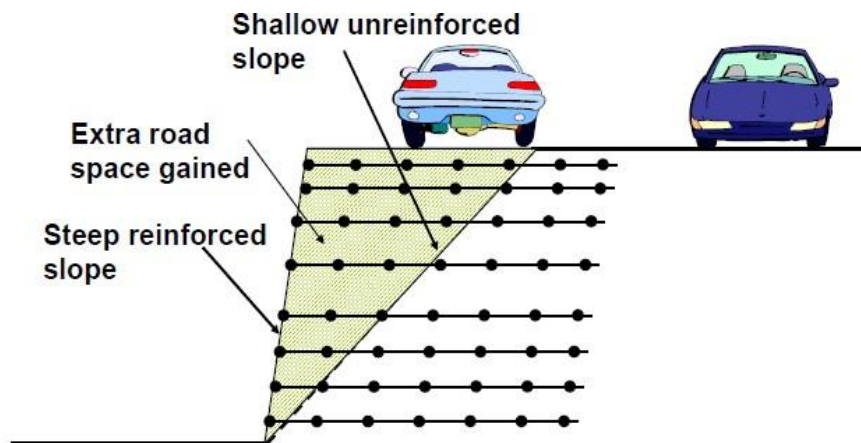

### Geosynthetic reinforcement layers

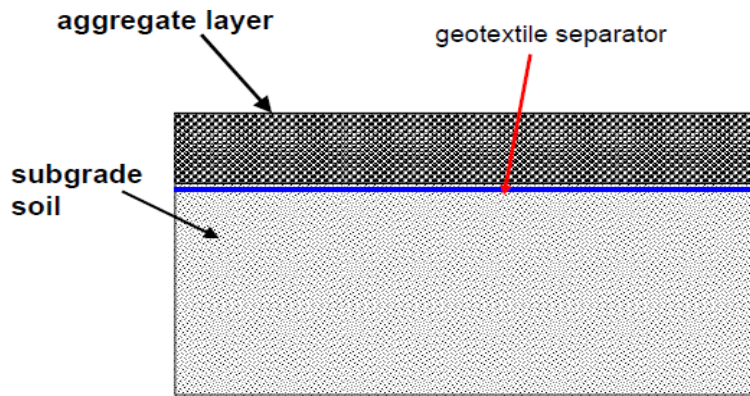

**Prevents the intermixing,  
prevents piping, strength of  
aggregate is preserved**

### **Separation Function in a pavement layer**

### **Filtration Function**

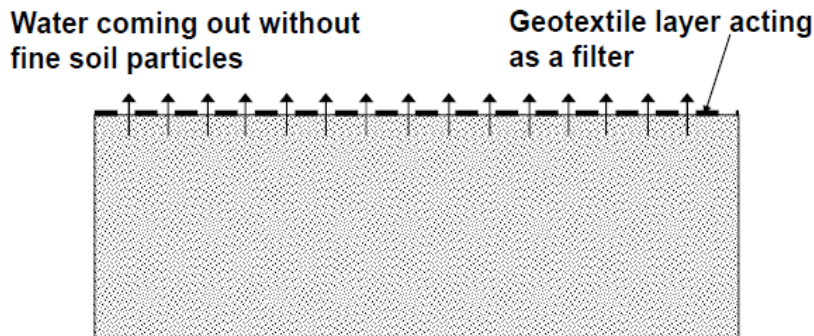

### **Surface Erosion protection**

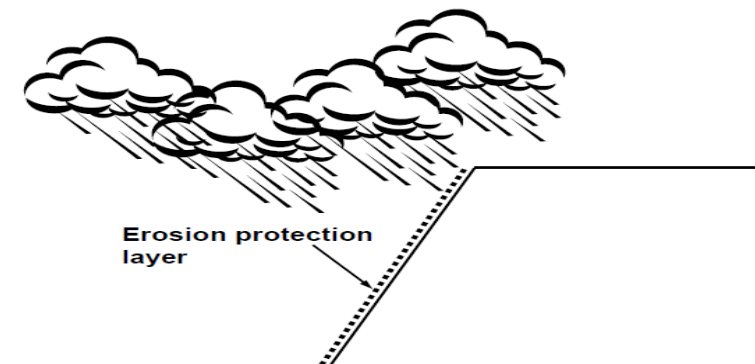

## Drainage function of a geotextile layer

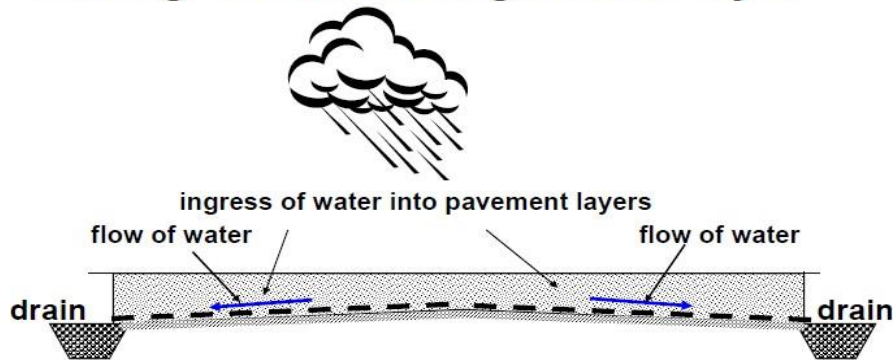

### How does the use of a geosynthetic as a filter differ from that of Drainage

Filtration applications are highway under drain systems, retaining wall drainage, landfill leachate collection systems, as silt fences and curtains, and as flexible forms for bags, tubes and container . Drainage applications for these different geosynthetics are retaining walls, sport fields, dams, canals, reservoirs, and capillary breaks.

### Preloading and vertical drains

In times of urbanization, growth of population and associated developments, construction activities are more and more focused on soils which were considered unsuitable in the past decades. These soft soil deposits have a low bearing capacity and exhibit large settlements when subjected to loading. It is therefore inevitable to treat soft soil deposits prior to construction activities in order to prevent differential settlements and subsequently potential damages to structures. Different ground improvement techniques are available today. Every technique should lead to an increase of soil shear strength, a reduction of soil compressibility and a reduction of soil permeability. The choice of ground improvement technique depends on geological formation of the soil, soil characteristics, cost, availability of backfill material and experience in the past. According to Bergado et al. (1996) they can be divided broadly into two categories. The first category includes techniques which require foreign materials and utilisation of reinforcements. They are based on stiffening columns either by the use of a granular fill (stone columns), by piling elements which are not reaching a still soil stratum (creep piles) or by in situ mixing of the

soil with chemical agents (deep stabilisation). The second category includes methods which are strengthening the soil by dewatering, i.e. preloading techniques often combined with vertical drains. This report will focus on preloading techniques and utilisation of vertical drains. Preloading is the application of surcharge load on the site prior to construction of the permanent structure, until most of the primary settlement has occurred. Since compressible soils are usually characterized by very low permeability, the time needed for the desired consolidation can be very long, even with very high surcharge load. Therefore, the application of preloading alone may not be feasible with tight construction schedules and hence, a system of vertical drains is often introduced to achieve accelerated radial drainage and consolidation by reducing the length of the drainage paths.

### **Pre-fabricated vertical drains to accelerate the pre-consolidation of soft clay soils**

$$T_v = \frac{c_v t}{d^2}$$

$$T_v \Rightarrow f(U\%)$$

$$t = \frac{T_v d^2}{c_v}$$

**T<sub>v</sub> = time factor**

**t = time**

**c<sub>v</sub> = coefficient of consolidation**

**d = drainage path length**

**U% = degree of consolidation**

#### **Reducing the flow path length to accelerate rate of consolidation**

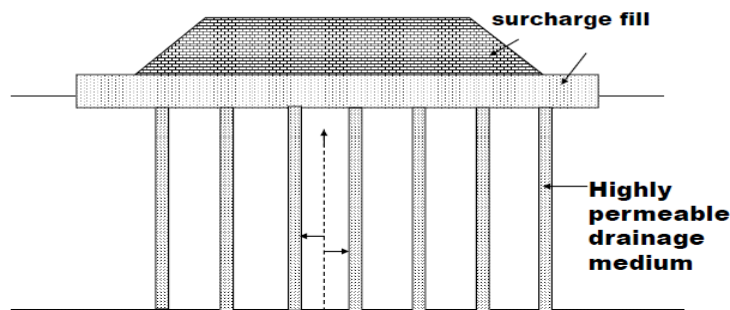

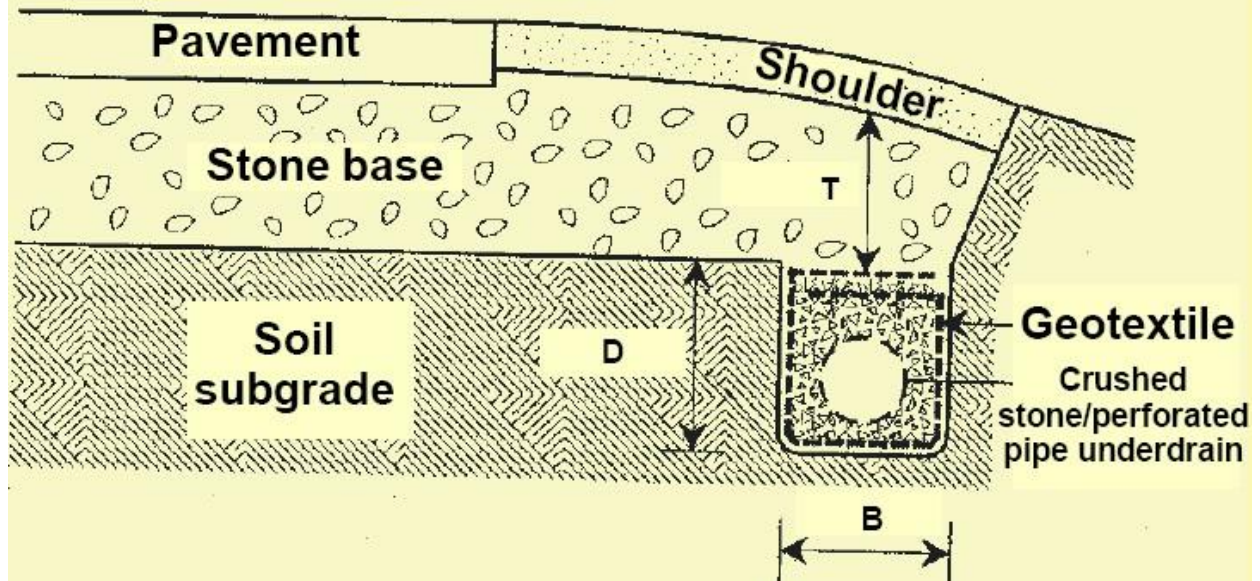

### Typical Applications of geosynthetics as drainage material

- Pavement edge drains
- Interceptor trenches on slopes
- Drainage behind abutments and retaining structures
- Relief of water pressure on buried structures
- Substitute for conventional drains
- Leachate collection and gas venting
- Drainage mats in horizontal applications e.g. roofing
- PVDs for accelerated consolidation of clay soils

## UNIT- 4

### **Physical & Chemical Modification**

Chemical admixtures are the ingredients in concrete other than portland cement, water, and aggregate that are added to the mix immediately before or during mixing. Producers use admixtures primarily to reduce the cost of concrete construction; to modify the properties of hardened concrete; to ensure the quality of concrete during mixing, transporting, placing, and curing; and to overcome certain emergencies during concrete operations.

Successful use of admixtures depends on the use of appropriate methods of batching and concreting. Most admixtures are supplied in ready-to-use liquid form and are added to the concrete at the plant or at the jobsite. Certain admixtures, such as pigments, expansive agents, and pumping aids are used only in extremely small amounts and are usually batched by hand from premeasured containers.

Admixtures are classed according to function. There are five distinct classes of chemical admixtures: air-entraining, water-reducing, retarding, accelerating, and plasticizers (superplasticizers). All other varieties of admixtures fall into the specialty category whose functions include corrosion inhibition, shrinkage reduction, alkali-silica reactivity reduction, workability enhancement, bonding, damp proofing, and coloring. Air-entraining admixtures, which are used to purposely place microscopic air bubbles into the concrete, are discussed more fully in Air-Entrained Concrete.

**Water-reducing admixtures** usually reduce the required water content for a concrete mixture by about 5 to 10 percent. Consequently, concrete containing a water-reducing admixture needs less water to reach a required slump than untreated concrete. The treated concrete can have a lower water-cement ratio. This usually indicates that a higher strength concrete can be produced without increasing the amount of cement. Recent advancements in admixture technology have led to the development of mid-range water reducers. These admixtures reduce water content by at least 8 percent and tend to be more stable over a wider range of temperatures. Mid-range water reducers provide more consistent setting times than standard water reducers.

**Retarding admixtures**, which slow the setting rate of concrete, are used to counteract the accelerating effect of hot weather on concrete setting. High temperatures often cause an increased rate of hardening which makes placing and finishing difficult. Retarders keep concrete workable during placement and delay the initial set of concrete. Most retarders also function as water reducers and may entrain some air in concrete.

**Accelerating admixtures** increase the rate of early strength development, reduce the time required for proper curing and protection, and speed up the start of finishing operations. Accelerating admixtures are especially useful for modifying the properties of concrete in cold weather.

**Superplasticizers**, also known as plasticizers or high-range water reducers (HRWR), reduce water content by 12 to 30 percent and can be added to concrete with a low-to-normal slump and water-cement ratio to make high-slump flowing concrete. Flowing concrete is a highly fluid but workable concrete that can be placed with little or no vibration or compaction. The effect of superplasticizers lasts only 30 to 60 minutes, depending on the brand and dosage rate, and is followed by a rapid loss in workability. As a result of the slump loss, superplasticizers are usually added to concrete at the jobsite.

**Corrosion-inhibiting admixtures** fall into the specialty admixture category and are used to slow corrosion of reinforcing steel in concrete. Corrosion inhibitors can be used as a defensive strategy for concrete structures, such as marine facilities, highway bridges, and parking garages, that will be exposed to high concentrations of chloride. Other specialty admixtures include shrinkage-reducing admixtures and alkali-silica reactivity inhibitors. The shrinkage reducers are used to control drying shrinkage and minimize cracking, while ASR inhibitors control durability problems associated with alkali-silica reactivity.

### **Lime Stabilisation**

1. Stabilization using lime is an established practice to improve the characteristics of fine grained soils.
2. The first field applications in the construction of highways and airfields pavements were reported in 1950- 60. With the proven success of these attempts, the technique was



extended as for large scale soil treatment using lime for stabilization of subgrades as well as improvement of bearing capacity of foundations in the form of lime columns.

### **Mechanism of lime stabilization**

The addition of lime affects the shear strength, compressibility, and the permeability of soft clays. These beneficial changes occur due to the diffusion of lime.

Soil-lime reaction

1. Cation-exchange
2. Flocculation
3. Aggregation (time and temperature dependent)

#### **❖ Cation Exchange**

1. It is an important reaction and mainly responsible for the changes occurring in the plasticity characteristics of soil.
2. The cation replacement takes place in order of their replacing power  
$$\text{Li}^+ < \text{Na}^+ < \text{H}^+ < \text{K}^+ < \text{NH}_4^+ < \text{Mg}^{2+} < \text{Ca}^{2+} < \text{Al}^{3+}$$
3. CEC highly depends on the pH of the soil water and the type of clay mineral in the soil.

Montmorillonite (highest); Koalinite (Lowest).

4.  $\text{Ca}(\text{OH})_2$  [ formed either due to hydration of quicklime or when it is used directly] dissociates in the water.



5. It increases the electrolytic concentration and pH of the pore water and dissolves the silicates ( $\text{SiO}_2$ ) and aluminates ( $\text{Al}_2\text{O}_3$ ) from the clay particles.

6.  $\text{Na}^+$  and other cations adsorbed to the clay mineral surfaces are exchanged with  $\text{Ca}^{++}$  ions.

#### ❖ Flocculation

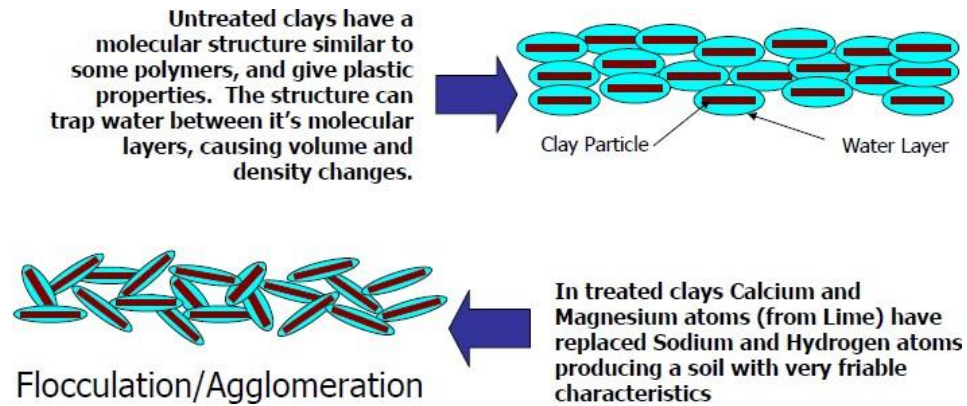

#### ❖ Pozzolanic

- Literature review reveals that the addition of lime to soil alters the properties of soil and this is mainly due to the formation of various compounds such as calcium silicate hydrate (CSH) and calcium aluminate hydrate (CAH) and micro fabric changes (Pozzolanic reaction).
- $\text{Ca}^{2+} + 2(\text{OH}^-) + \text{SiO}_2 \rightarrow \text{CSH}$
- $\text{Ca}^{2+} + 2(\text{OH}^-) + \text{Al}_2\text{O}_3 \rightarrow \text{CAH}$
- The reaction is much slower reaction than the hydration of cement and hence some times cement is added to increase the rate of reaction.

### FACTORS CONTROLLING THE CHARACTERISTICS OF LIME TREATED CLAY

1. Type of lime (Quick lime or Hydrated lime)
2. Lime content (Lime Fixation Point and Optimum lime content)
3. Curing time
4. Type of soil
5. Clay mineral

6. Soil pH
7. Curing temperature

Variation of index properties with addition of lime

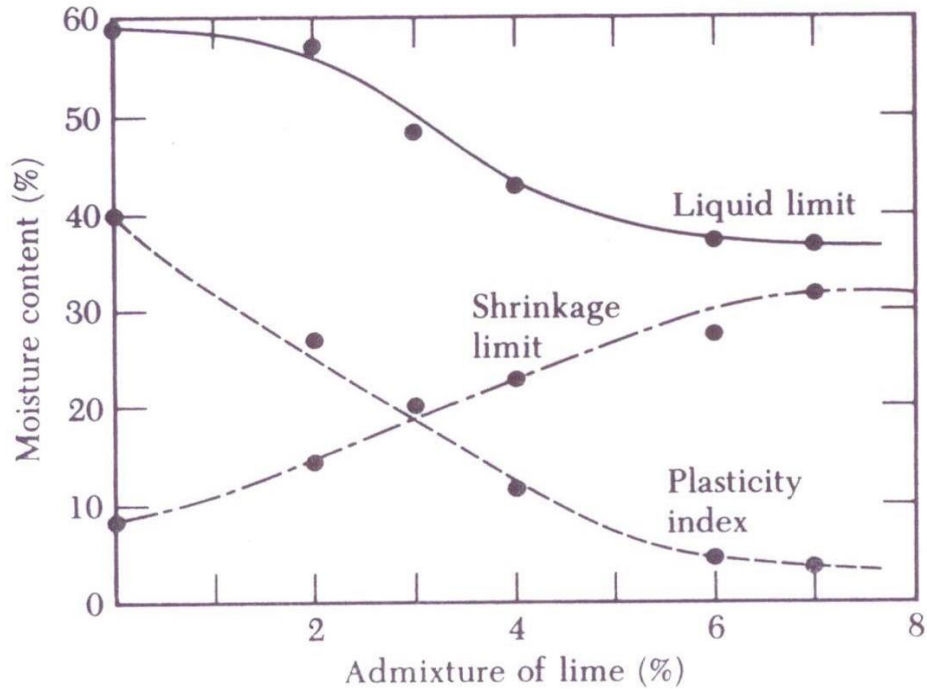

**Preparation of the soil:** to remove large elements which might hinder the mixing-in of lime, and it also helps to modify the humidity of the soil. It may be carried out with a ripper, a harrow or a plough.

**Spreading:** the lime is dispersed using a spreader fitted with a weighing device. The lime is supplied pneumatically to the spreader, either directly from the silo vehicle or by using buffer silos.

**Mixing:** the purpose of this operation is to spread out the soil while at the same mixing the lime evenly into it. this work will be done with pulvimixers, rotary paddle mixers, disk ploughs or plough shares

**Compaction:** when grading, the layer thickness that can be compacted by rolling should be taken into account. After grading, the treated soil has to be compacted using a compacting machine (pneumatic-tyre roller or tamping roller). In warm weather, mixing should be done after two hours to allow for reactions.

### Lime Columns

1. Broms and Bomans (1975, 1979) used a special type of auger to form the bores in which lime was mixed with the soil in-situ.
2. In this technique it was assumed that the improved soil column in the bore was acting as a pile to support the superstructure.
3. Later it was found that lime can diffuse into the surrounding soil and can stabilize a greater volume of soil.

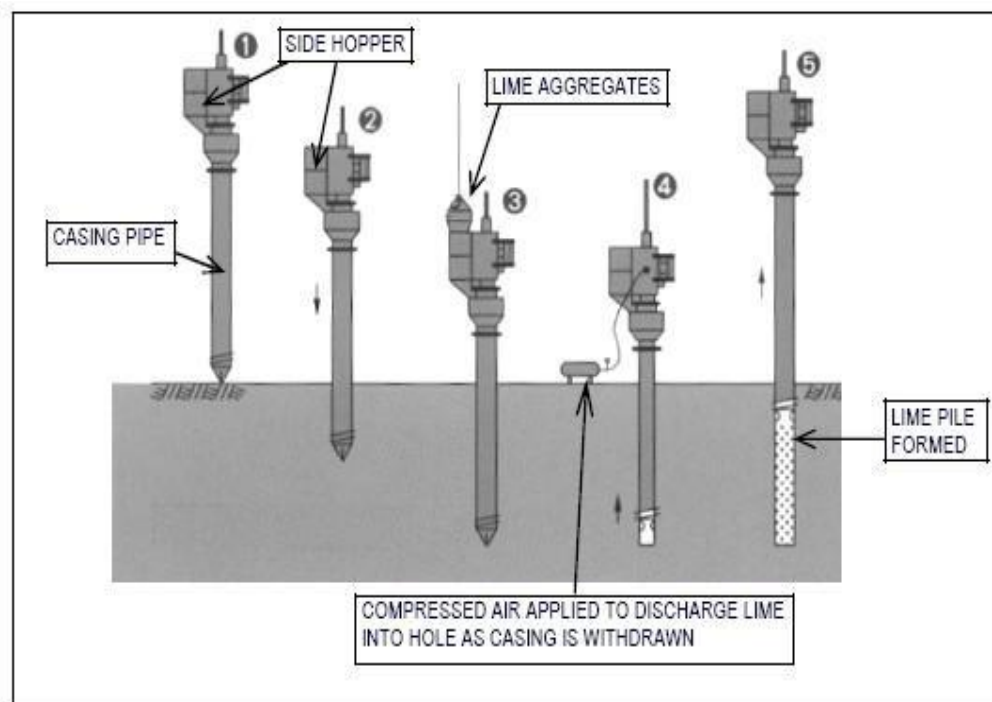

This method produces both a consolidation and strength gain effect on the treated soil, without additional loading, via lateral expansion of the lime columns as they absorb water from the soft soil.

**These lime columns have the following effects on the adjacent soil.**

***a) Consolidation / dewatering effect***

Quick lime, CaO, absorbs water from the surrounding ground, causing the lime to swell and forms slaked lime (Ca(OH)<sub>2</sub>) as per the following chemical reaction



***b) Ion exchange effect***

As the surface of fine particles of clay is negatively charged, calcium ions (Ca<sup>++</sup>) from the slaked lime are absorbed by the surface of clay particles. As a result, clay particles are bonded with each other and the weak clay is improved with a resultant increase in shear strength.

***c) Pozzolanic effect***

Calcium ions continue to react with SiO<sub>2</sub> and Al<sub>2</sub>O<sub>3</sub> in the clay for a long time forming compounds that cause the clay strength to be improved. This reaction is termed a pozzolanic reaction. The lime piles themselves have considerable strength and therefore act to reinforce the soil as well as alter its properties.

*Among all the three effects only consolidation/dewatering effect is the main process by which the strength and stiffness of the soil mass is improved in the shorter term. Other two effects ion exchange effect and pozzolanic effect are ignored.*

**Shear strength improvement**

The shear strength of the soil stabilized in the field (in situ) was much higher than that of the samples prepared in the laboratory. The soil stabilized in situ is subjected to a pressure from the overburden and from the surrounding soil while the confining pressure for the samples that were stored in small containers in the laboratory is small.

## **GROUND TREATMENT WITH CEMENT**

Stabilization using cement and other admixtures such as fly ash, blast furnace slag has been adopted in many geotechnical and highway engineering projects. These applications include

- a) Shallow depth applications in the case of improvement of subgrade, sub-base and base course of highways and embankment material
  - b) Stabilization of deep soil deposits such as soft soils and peaty soils.
- Addition of small quantities of cement proved to be beneficial and the degree of strength/stiffness required is the basis for design and has been used in the stabilization of highways and embankments.
  - In large scale applications, depending on the strength and stiffness required based on the type of soil, the quantities required are huge and need large scale machinery and special procedures are required in stabilization of deep soils which are weak (Eg: peaty soils).

Benefits:

1. Increased strength and stiffness
2. Better volume stability
3. Increased durability

### **Factors influencing the strength and stiffness improvement**

1. Cement content, water content combined into water/cement(w/c) ratio.
2. Method of compaction.
3. Time elapsed between mixing and compaction.
4. Length of curing.
5. Temperature and humidity.
6. Specimen size and boundary effects.

Strength gain is given by:

$$q_u(t) = q_u(t_0) + k \log \frac{t}{t_0}$$

$q_u(t)$  = the UCC (unconfined compression) strength at  $t$  days

$q_u(t_0)$  = the UCC strength at  $t_0$  days

$k = 480C$  for granular soils;  $70C$  for fine grained soils

$C$  = Cement content by weight

Effect of adding cement and blast furnace slag leads to the following chemical reactions:

1. Hydration of cement produces  $\text{Ca(OH)}_2$ . The calcium hydroxide generated is upto 25% of the weight of cement.
2. Adsorption of  $\text{Ca(OH)}_2$  by the clay, cation exchange reaction
3. If the clay is saturated with  $\text{Ca(OH)}_2$ , a pozzolonic reaction between the components occurs.

**The design and construction of a soil treatment project is generally as follows:**

1. Site exploration discloses geotechnical conditions that don't meet design criteria such as density, consistency, strength, or permeability.
2. Alternative treatment methods are evaluated.
3. Specialty contractors are selected.
4. Laboratory mix testing is conducted to provide guideline on in situ soil characteristics, tolerable admixture properties, and optimum mix designs

5. Owner approves contractor's equipment, methods, and mix design.
6. Soil at site is treated with close supervision, sampling, and testing in the field to make sure that project requirements are met.

### **Soil Stabilization**

Improving the engineering properties of soils used for pavement base courses, subbase courses, and subgrades by the use of additives which are mixed into the soil to effect the desired improvement.

### **Shotcreting and Guniting Technology**

Shotcrete and guniting are important terminologies associated with the domain of civil construction. Shotcreting or guniting are techniques or processes that have proven to be of immense benefit in diverse subdomains of construction such as slope protection or stabilisation, pools, tunnels, fluid tanks, concrete repair works and many more. Many of us, including this author, have not only studied about shotcreting or guniting but also have practical experience of varying degrees in this particular area.

Yet, when it comes to defining or differentiating between these two terms there would, in all probability, be lack of unanimity. Can't blame one though, as some of the established and experienced producers and companies involved in the application of shotcrete or guniting themselves do not seem to converge on an identical interpretation of these terms. While some consider guniting as a type (class) of shotcreting some others still regard them as two completely different processes.

Confusion brewing up already ? Let's have a bit more of that. For American Shotcrete Association (ASA), apparently, the terms guniting or guniting simply do not exist – technically. ASA only believes in the term shotcrete and according to it there exist only dry-mix shotcrete and wet-mix shotcrete. Take your pick.

Nevertheless, what everyone agrees on is that there are two processes involved when it comes to spraying concrete or mortar pneumatically through a spraying gun (nozzle) at high velocity onto



a surface. One is called the dry-mix process while the other wet-mix process. Also, whoever uses the terms gunite or guniting uses them to mean the dry-mix process only and never the wet-mix one.

The dry-mix process involves mixing cement and aggregates (fine or both fine & coarse aggregates) completely dry in a bin, rig etc and the pumping the same through a hose pneumatically (ie using compressed air by a compressor) under high pressure to a nozzle (the spray-gun). Water is introduced to the dry mix only at the nozzle (by means of a water feeding line) just before the mix blasts off the nozzle at a high velocity onto the surface being treated. On the other hand, the wet-mix process involves spraying of a pre-mixed or ready-mixed (wet) concrete or mortar under high pressure and at high velocity eliminating the need of adding any water in the nozzle or the spray-gun. Both processes have their unique advantages and requirements. But, the questions still remain as to what exactly is shotcrete and what is gunite, are they the same or different, if different, what are the differences etc etc.

So, let's turn the heads into the ones who originally coined these terms, developed these techniques or set them in motion since and then see what shows up.

A little bit of study on the subject quickly reveals that it was the term "gunite" that came into existence first. The term was used to describe a then newly developed technique in US in which concrete was used to be sprayed under pressure through a spray-gun at high velocity onto a surfacing requiring such an application. Since the material was sprayed through a gun, the term gunite seems to have surfaced. All these happened at the dawn of the previous century.

Later, the term "shotcrete" came into being for the first time in the early 1930s when the American Railway Engineers Association (AREA) started using it to describe concrete (or mortar) nozzle-sprayed pneumatically at high velocity onto a surface either by dry-mix or by wet-mix process.

In the early 1950s the American Concrete Institute (ACI) too adopted the term "shotcrete" to describe the dry-mix spraying process erstwhile known as guniting. ACI classified the

shotcreting process into two types, namely, the dry-mix process and the wet-mix process. They also accepted the term guniting for the dry-mix shotcreting process. In other words, according to ACI, guniting is a type of shotcreting only.

Contrary to that, some seem to regard “gunitite” merely as a trademark only. Let’s take an example. Xerox is a popular trademark while the process involved is photocopying and not xeroxing. Similarly, this section believes that while gunitite can exist as a trademark or brand name the term guniting is meaningless and the technically correct term is shotcreting (dry-mix) only. Some others don’t seem to agree however.

This author would prefer to have the following views and would suggest the same to others as well :- The process or technique that involves pumping of concrete or mortar under high pressure through a hose to a nozzle (spray-gun) and then spraying them at high velocity onto a surface either by dry-mix or by wet-mix process is called shotcreting. Usually, shotcrete is reinforced by using steel or wire mesh, steel rebars, synthetic fibres etc. Since, the dry-mix shotcreting is also called as guniting by some (yet, not by all), better to stick to the terms dry-mix shotcreting & wet-mix shotcreting rather than guniting.

Nevertheless, if one is highly used to the terms gunitite and guniting, or, if one is dealing with an entity that is hell bent on using the terms gunitite and guniting, the same may be used to mean the dry-mix shotcreting method only. Also, it is to be noted that a mix sprayed under low pressure and at low velocity is usually not regarded as either gunitite or shotcrete. One of the basic purpose of these processes is to achieve very high degree of compaction and thus high strength due to the high-velocity ejection from the spray-gun eliminating the need of any further compaction. This also eliminates the need of any formwork. The high velocity of the mix also ensures better adhesion with the receiving surface. The velocity is usually well over 100 m/s, say about 150 m/s, but can be even higher if situation demands.

Also, when it comes to guniting, usually, smaller sized coarse aggregates, say max. 10mm or so, are used. For the wet-mix process use of aggregates of max. size of 1 inch or so is not uncommon.

The dry-mix shotcreting process (aka guniting) seems to be the most widely used method worldwide due to certain unique advantages it has to offer as mentioned below:

1. It's extremely versatile. This process can be used to give virtually any shape to any element of a structure – curved, undulating, spheroidal and many more. This is a reason why this process is commonly adopted to add special features or shapes to swimming pools, spas, artificial caves & waterfalls etc. It is used in sculpting work as well. It's versatility makes it an excellent candidate for a large variety of work such as tunnel lining, refractory lining, slope protection, repair works besides making it suitable for diverse uses in structures like tanks, dams, reservoirs, canals, docks, bridges, pipelines etc.

2. Water content of the mix can be controlled instantly and at any time at the nozzle by the crew while spraying the mix onto a surface. This enables one – at any moment – to render the mix only as much dry or wet as the situation demands by controlling the addition of water at the nozzle.

3. Dry-mix shotcrete (gunite) is quite economical, can be quickly prepared and applied unlike the wet-mix variety. It is quite suitable for overhead application where wet-mix shotcrete may not stick well and may sag or fall off.

4. If very thin linings or coatings are required to be applied on a surface or if the quantum of the work is small or in case of concrete repairs needing finer treatments such as filling up of cracks or small broken patches, damage etc, guniting would be a the choice rather than wet-mix shotcreting.

5. If the application job involves frequent stops of work for some reason or another guniting could be a much better choice over the wet-mix application.

Dry-mix process or guniting needs highly skilled crew. That's especially true for the nozzleman as he is the one who controls and monitors the water flow at the nozzle. This demands experience and skill.

Another issue with guniting is "rebound". While spraying the mix onto a surface some amount of the material is bound to bounce off the surface and fall on the ground. This occurrence is known as rebound and is unavoidable in guniting or even in wet-mix shotcreting as well. The rebound-quantity is a complete waste as reuse of the same would result in an inferior product. Lesser rebound not only minimises waste but also indicates a better quality mix and thus a better product. Experience and skill are necessary qualities in order to get the better of the rebound problem partially.

The wet-mix shotcreting process also finds a lots of use. In fact, if stronger linings or coatings are the need of the hour in a particular work, wet-mix shotcrete can be a better choice than gunite as it results in a stronger product. Except where special or curved features are necessary calling for decorative or artistic finishes, wet-mix shotcreting can be applied virtually on all occasions as already mentioned earlier in this article where guniting can be implemented.

A better control over quality of the material is possible in case of the wet-mix process since all ingredients of the mix, including water, are pre-mixed before pumping the same to the spray gun. So, the mix can be precisely designed in accordance with the requirements like strength, durability etc. Also, rebound is much lesser for wet-mix shotcreting as compared to dry-mix shotcreting (guniting). For work involving large quantity of mix wet-mix shotcreting process is quite convenient, especially, if the work is continuous with no or very less stops.

At the end of the day, it's much more important to choose the right or more suitable process (dry-mix or wet-mix) for a particular work and ensure that the same is properly & skillfully implemented rather than bothering too much about whether to call it dry-mix shotcreting or guniting.

## **GROUTING.**

Grouting is defined as the process of injecting suitable fluid under pressure into the subsurface soil or rock to fill voids, cracks and fissures for the purpose of improving the soil.

The fluid may be colloidal solutions, cement suspensions, chemical solutions etc.

### **Application of Grouting**

1. Producing mass concrete structures and piles
2. Fixing ground anchors for sheet pile walls, concrete pile walls, retaining walls tunnels etc
3. Repairing a ground underneath a formation or cracks
4. Defects on building masonry or pavement
5. Fixing the tendons in prestressed post tensioned concrete
6. Filling the void between the lining and rock face in tunnel works
7. Seepage control in soil
8. Soil stabilization and solidification
9. Vibration control

### **Various types of grouting.**

Suspension grouts

Solution Grouts

Colloidal solution grouts

### **Suspension grouts**

These are multi-phase systems capable of forming sub systems after being subjected to natural sieving processes, with chemical properties which must ensure that they do not militate against controlled properties of setting and strength. Water in association with cement, lime, soil, etc., constitute suspensions. Emulsion (asphalt or bitumen) with water is a two-phase system which is also included under suspension. Solution Grouts These are intimate one-phase system retaining an originally designed chemical balance until completion of the relevant reactions. Silicate derivatives, lignosulphite derivatives, phenoplast resins etc. come under this category. Colloidal solution grouts Solutions in which the solute is present in the colloidal state are known as colloidal solutions. Chemical grouts fall into this category.

## Different types of Grouting

- i. Compaction grouting
- ii. Compensation grouting
- iii. Jet grouting

### Compaction Grouting

- Compaction grouting is a single-stage grouting with high strength mortar to the ground to create a grout-bulb at the end of drill pipe.
- Grouting Mechanism
  - A stiff grout with a very low slump is injected under relatively high pressure through pipes or casings into soil. The grout exiting the bottom of the pipe forms a bulb-shaped mass that increases in volume.
  - Displacement of the soil is produced by the weight of the overburden pushing back against the expanding grout bulb. Thus it densifies the soft, loose, or disturbed soil surrounding the mass.
  - It can also be used to alleviate settlement problem during the excavation of tunnel or deep basement as the hardened bulb-shaped grout will induce an increase in the soil volume strain to the soil strata and cause heaving of ground at the ground surface.
  - When applying the compaction grouting process usually a stiff to plastic grout is injected into the soil under pressure.
  - It expands in the soil as a relatively homogeneous mass and at the same time is forming almost ball-shaped grout bulbs.
  - The soil surrounding the grouted area is displaced and at the same time compacted.



- Compared to other grouting techniques, the grout material neither penetrates into the pores of the in-situ soil (as is the case with the classical injection) nor are local cracks formed (as is the case with the Soilfrac® technique).
- During the compaction grouting process pressure and grout quantity as well as possible deformations at ground surface, respectively at structures are monitored.

### **Applications of Compaction Grouting**

- The compaction grouting method may be used for the improvement of non-cohesive soils, especially in cases, where soils of loose to medium density are encountered.
- This method is also used in fine-grained soils) in order to install elements of higher strength and bearing capacity in soils of low bearing capacity, thus improving the load bearing behaviour of the soil.
- When using this technique in saturated clayey soil, a temporary increase of the pore water pressure can be observed.
- In principle, the compaction grouting technique can achieve a similar degree of improvement as by the deep vibro techniques.
- The compaction grouting method is particularly well suited as an alternative or supplement to deep vibro techniques in the following cases:
  - confined working space
  - limited working height
  - vibration-free technique required (e.g. because of a highly sensitive structure in the vicinity)
  - compaction at very large depths for intermittent strong soil layers, which cannot be penetrated by a depth vibrator, thus making its use inefficient.

### **Compensation Grouting**

- Compensation grouting is a grout injection that can „compensate“ for stress relief and associated ground settlement.
- Grout is injected through grout pipes, which are usually TAM grout pipes, under high pressure into the soil.
- Fractures in soil are created which are then filled with grout.

- The fractures filled with grout will follow the plane with the minor principle stress and formed in layers.
- The increase in volume will compact disturbed soil surrounding the mass, will compensate settlement caused by tunnel Excavation works and can be used to lift up settle structures.

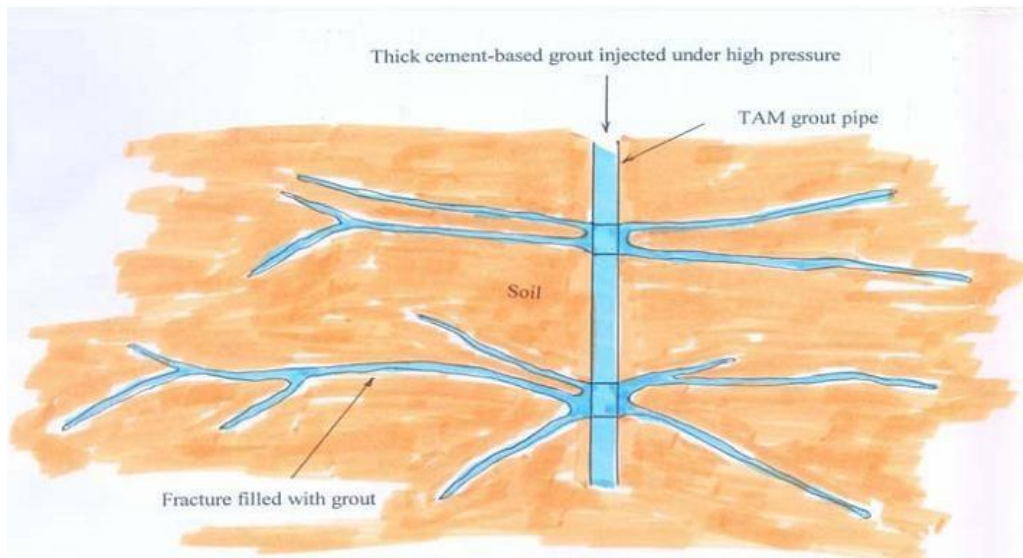

In using this process fractures in the soil are created which are then filled with grout. Each soil formation may be improved by multiple grouting treatments and controlled lifting may be induced.

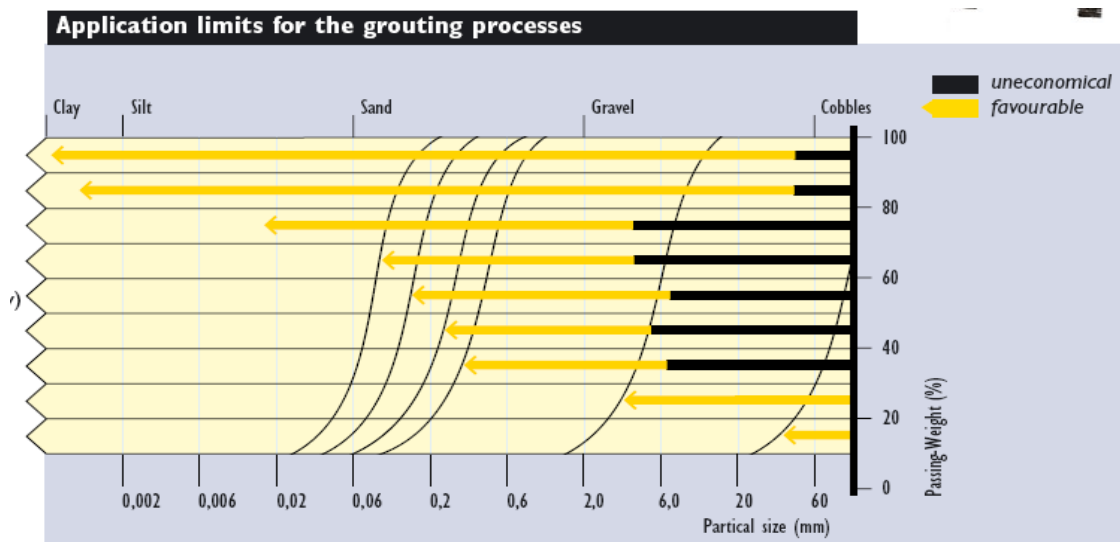



## JET GROUTING / SOILCRETING

- Depending on the nature of soils, Soilcrete®- cut-offs are able to reduce the coefficient of permeability by several decimal powers. High quality requirements in respect of the degree of sealing effect necessitate extensive production efforts.
- For many applications both the strengthening and sealing characteristics of the Soilcrete®-elements are used. The selected suspensions need to be composited accordingly.

Soilcrete is produced in three different ways.

1. Single Direct Process
2. Double Direct Process
3. Tripple Separation Process

The method to be used is determined according to the prevailing soil conditions, the geometrical form and the required quality of the Soilcrete-elements.

### Single direct process:

- Operates with a grout jet of min. 100 m/sec. exit velocity for simultaneous cutting and mixing of the soil without an air schroud.
- The process is used for small to medium sized jet grout columns.

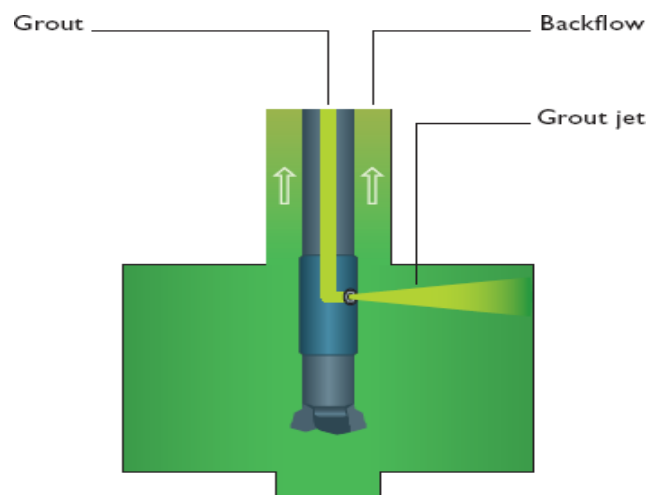

### Double direct process:

- operates with a grout jet of min. 100 m/sec exit velocity for simultaneous cutting and mixing of the soil.
- To increase the erosion capability and the range of the grout jet, air shrouding by means of shaped air jet nozzle is used.
- The process is mainly used for panel walls, underpinning and sealing slabs.

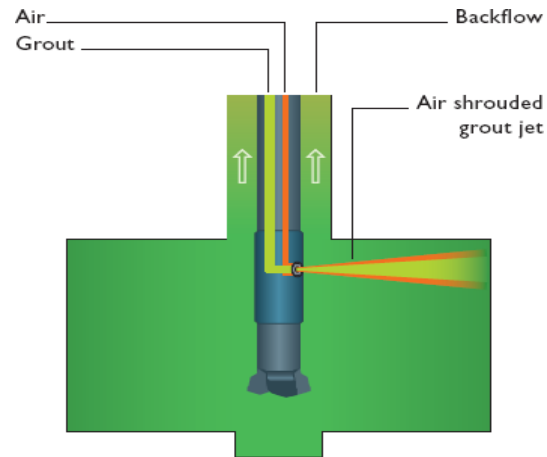

### Triple separation process:

- Erodes the soil with an air shrouded water jet of min. 100 m/sec exit velocity.
- Grout is injected simultaneously through an additional nozzle located below the water jet nozzle.
- The grout pump pressure ranges above 15 bar.
- The process is used for underpinning works, cut off walls and sealing slabs and is mainly used for the treatment of cohesive soils.

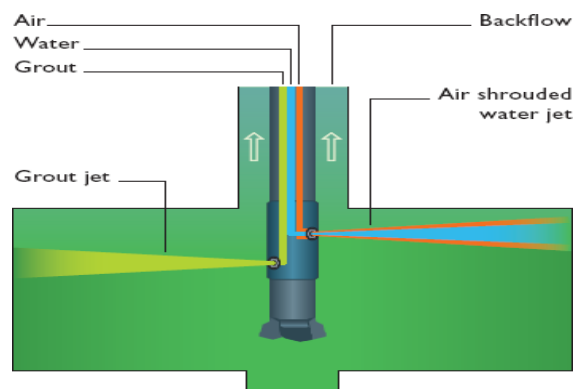

## Applications of Jet Grouting

- ❑ The jet grouting technique is developed in the 1960s. However, because of its unique properties, it is becoming quite popular in the civil engineering works. Its main applications are: -
- ❑ Grouting of clay / silt soils which is not suitable for TAM grouting technique.
- ❑ Jet grout wall and roof are used to reinforce tunnel portal excavation works.
- ❑ Sealing of windows of coffer dams
- ❑ Used as jet grout raft to reinforce cofferdam to limit its deflection and thus decrease the settlement caused by the excavation works.

## HEATING AND FREEZING METHOD

Changes in soil state due to water content variation are effected by hydraulic modification methods. Changes in soil structure apart from water content variations are brought about using modifications based on temperature and use of appropriate modifiers.

Methods based on temperature control are classified as:

1. Heat treatment method.
2. Ground freezing method.

### ❖ Heating methods

- Temperature control methods depend on
  - Thermal conductivity of the soil
  - Heat capacity of the soil
  - Heat of fusion
  - Heat of vaporization

### Thermal conductivity of the soil

It is defined as the amount of heat passing through a unit cross-sectional area of soil under a unit temperature gradient.

$$K_T = \frac{q}{A(T_2 - T_1)/L}$$

$q$  = heat flow, watts, W;  $A$  = area of cross section,  $m^2$ ;  $T$  = temperature, K;  $L$  = length of the soil element, m;

At  $0^\circ\text{C}$   $KT$  for water =  $0.58 \text{ W/ m.K}$ , for ice =  $2.2 \text{ W/ m.K}$

For denser frozen sand  $KT = 4 \text{ W/ m.K}$  and less in unfrozen state,

For soils, thermal conductivity increases with water content and dry density.

### Heat capacity of a soil

It is expressed as the amount of heat required to raise the temperature by  $1^\circ\text{C}$  or  $1^\circ\text{K}$ . it is expressed in terms of unit volume (volumetric heat capacity) or per unit mass (specific heat capacity)

$$Q = CM \Delta T$$

Heat capacity of water  $C_w = 4.2 \text{ kJ/kg } ^\circ\text{C} = 4.2 \text{ MJ/m}^3 \text{ } ^\circ\text{C}$ .

ice  $C_i = 2.2 \text{ kJ/kg } ^\circ\text{C} = 2.2 \text{ MJ/m}^3 \text{ } ^\circ\text{C}$ .

Heat capacity of ice is less than that of water.

### Latent heat of fusion ( $L_F$ )

It is the change in thermal energy when water freeze or ice melts. It is  $334 \text{ MJ/m}^3$  of water.

To melt a mass  $M$  of ice, heat quality ( $Q$ )

$$Q = L_F M$$

For a  $1 \text{ m}^3$  of soil with water content  $w$

$$\begin{aligned} L_{Fs} &= \rho_d w L_F \\ &= 334 \rho_d w \text{ KJ/m}^3 \end{aligned}$$

### Heat of vaporization of water

It is the energy required to boil water from liquid state to gaseous state. At atmosphere,

Heat of vaporization of water =  $L_V = 2.26 \text{ MJ/kg} = 2260 \text{ MJ/m}^3$ .

To remove all the free water at  $100^\circ\text{C}$  in one  $\text{m}^3$  of soil with water content ( $w$ ), the energy required is

$$L_{Vs} = 2260 \rho_d W.$$

The above definitions are useful to calculate theoretical estimates, but losses need to be accounted for in design.

## **Heat treatment of soils**

Heat treatment of a clay soil to about 400°C results in pronounced changes in engineering properties.

Heating is energy intensive and to stabilize one m<sup>3</sup> of soil 50 to 100 liters of fuel oil are required.

It is not recommended now a days except in places where it is already available as inherent energy in waste products and in landfills. However use of geothermal piles as heating systems is prevalent in places like UK.

## **Methods of heating soil in-situ**

- Ground surface heating
- Heating through boreholes
- Use of thermally stabilized building blocks
- Thermal piles

Geothermal piles are an innovative system of building foundations for use in combination with ground-source energy technology. Conventional ground-loops are installed in building piles, through which water or another fluid is pumped. The fluid and ground-transfer heat energy is then passed through a heat exchanger in the building to provide cooling or, more commonly, heating in the winter. The geothermal system is essentially the same as closed-loop borehole systems; however, since they are installed in the building foundations, the technology serves a dual purpose.

## **Ground Freezing**

Ground freezing is a process of making water-bearing strata temporarily impermeable and to increase their compressive and shear strength by transforming joint water into ice.

- Freezing is normally used to provide structural underpinning; temporary supports for an excavation or to prevent ground water flow into an excavated area.
- Successful freezing of permeable water-bearing ground affects simultaneously a seal against water and substantial strengthening of incoherent ground.
- No extraneous materials need to be injected and apart from the contingency of frost heave, the ground normally reverts to its normal state.

- It is applicable to a wide range of soils but it takes considerable time to establish a substantial ice wall and the freeze must be maintained by continued refrigeration as long as required.
- May be used in any soil or rock formation regardless of structure, grain size or permeability. However, it is best suited for soft ground rather than rock conditions.
- Freezing may be used for any size, shape or depth of excavation and the same cooling plant can be used from job to job.
- As the impervious frozen earth barrier is constructed prior to excavation, it generally eliminates the need for compressed air, dewatering, or the concern for ground collapse during dewatering or excavation.

### **Principles of Freezing**

- The effectiveness of freezing depends on the presence of water to create ice, cementing the particles and increasing the strength of the ground to the equivalent of soft or medium rock.
- If the ground is saturated or nearly so it will be rendered impermeable.
- If the moisture does not fill the pores, it may be necessary to add water.
- The strength achieved depends on freeze temperature, moisture content and the nature of the soil.
- Freezing can be particularly effective in stabilizing silts, which are too fine for injection of any ordinary grouts.
- On freezing, water expands in volume by about 9% which does not itself impose any serious stresses and strains on the soil unless the water is confined within a restricted volume. With water content up to about 30% the direct soil expansion may be about 3%. Frost heave which may occur in fine silts and clays, is a slightly different phenomenon.
- In rock and clay ice lenses may build up and enlarge fine fissures so causing increase in permeability after thaw.
- If there is a flow of water through the ground to be frozen the freezing time will be **increased** by reason of the continuing supply of heat energy and, if the flow is large and the water temperature high, freezing may be completely inhibited.

- As in all ground treatment techniques, adequate site investigation is necessary to allow the best system to be chosen and to design the appropriate array of freezing tubes and select plant of adequate power.
- After the initial freezing has been completed and the frozen barrier is in place, the required refrigeration capacity is significantly reduced to maintain the frozen barrier
- Because freezing can be imposed uniformly on a wide range of soil types in a single operation, it may offer greater security in mixed ground than treatment by injection of various grouts.

### Applications

- Temporary underpinning of adjacent structure and support during permanent underpinning
- Shaft sinking through water-bearing ground
- Shaft construction totally within non-cohesive saturated ground
- Tunnelling through a full face of granular soil
- Tunnelling through mixed ground
- Soil stabilisation

Once the freezing process has begun, monitoring is required to ensure formation of the barrier wall and also to verify when freezing is complete. During the drilling process, temperature-monitoring pipes are installed to measure the ground temperature. Below are the techniques for temporary support of a tunnel heading by freezing:

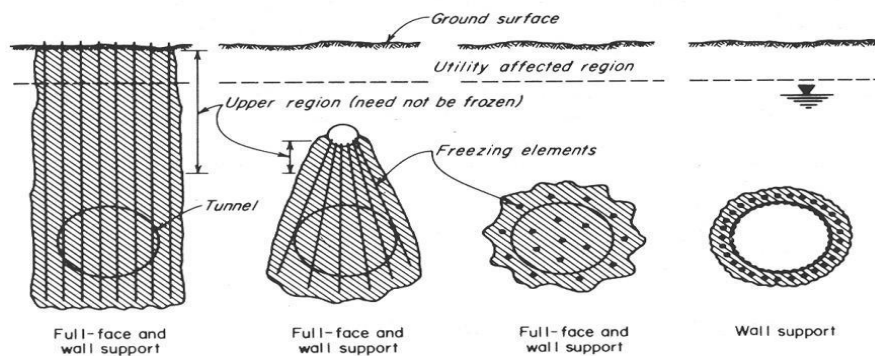

## Freezing process

Freezing may be:

- Indirect, by circulation of a secondary coolant through tubes driven into the ground
- Direct, by circulation of the primary refrigerant fluid through the ground tubes
- Direct, by injection of a coolant into the ground, such as liquid nitrogen.

## Indirect cooling

Primary refrigeration plant is used to abstract heat from a secondary coolant circulating through pipes driven into the ground. The primary refrigerant most commonly used will typically be some alternative to Freon, which due to its ozone-depleting characteristics had to be phased out until 1996. Other primary refrigerants are ammonia,  $\text{NH}_3$  ( $-33.3^\circ\text{C}$ ) and carbon dioxide,  $\text{CO}_2$  – now not commonly used. The secondary coolant, circulated through the network of tubes in the ground is usually a solution of Calcium Chloride. With a concentration of 30% such as brine has a freezing point well below that of the primary coolant.

The primary refrigeration process is basically the Carnot cycle of compression and expansion reversed. The time required to freeze the ground will obviously depend on the capacity of the freezing plant in relation to the volume of ground to be frozen and on the spacing and size of freezing tubes and water content in the grounds.





## **DIRECT COOLING**

- In these systems the primary refrigerant is circulated through the system of tubes in the ground, extracting directly the latent heat, therefore having a higher efficiency than the indirect process.
- Direct freezing time is similar to that for the indirect process. The choice will depend on plant availability, estimates of cost and perhaps personal preference.

## **Liquid Nitrogen (LN<sub>2</sub>)**

- With this method a large portable refrigeration plant is not necessary, and the temp is much lower and therefore quicker in application. The nitrogen under moderate pressure is brought to site in insulated containers as a liquid which boils at  $-196^{\circ}\text{C}$  at normal pressure and thereby effects the required cooling. It can be stored on site.
- There is a particular advantage for emergency use, i.e quick freezing without elaborate fixed plant and equipment. This may be doubly advantageous on sites remote from power supplies. In such conditions the nitrogen can be discharged directly through tubes driven into the ground, and allowed to escape to atmosphere. Precautions for adequate ventilation must be observed.



- When there is time for preparation, an array of freezing tubes is installed for the nitrogen circulation, including return pipes exhausting to atmosphere.
- The speed of ground freezing is much quicker than with other methods, days rather than weeks, but liquid nitrogen is costly.

- The method is particularly appropriate for a short period of freezing up to about 3 weeks. It may be used in conjunction with the other processes with the same array of freezing tubes and network of insulated distribution pipes, in which liquid nitrogen is first used to establish the freeze quickly and is followed by ordinary refrigeration to maintain the condition while work is executed. This can be of particular help when a natural flow of ground water makes initial freezing difficult.
- The design of a frozen earth barrier is governed by the thermal properties of the underlying soils and related response to the freezing system.
- Formation of frozen earth barrier develops at different rates depending on the thermal and hydraulic properties of each stratum. Typically, rock and coarse-grained soils freeze faster than clays and silts.

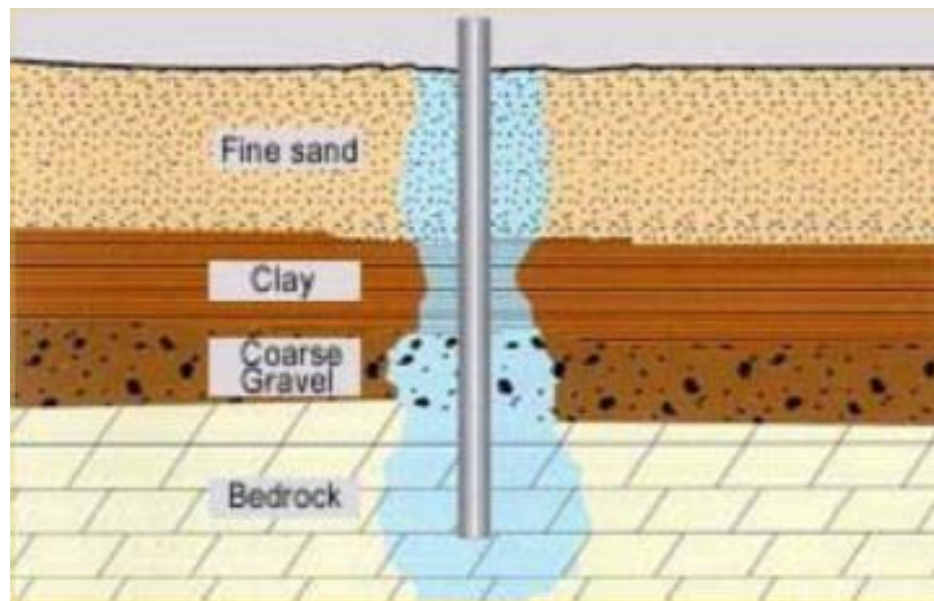

- When soft clay is cooled to the freezing point, some portion of its pore water begins to freeze and clay begins to stiffen. If the temperature is further reduced, more of the pore water freezes and the strength of the clay markedly increases.
- When designing frozen earth structures in clay it may be necessary to provide for substantially lower temperatures to achieve the required strengths.
- A temperature of +20 °F may be adequate in sands, whereas temperatures as low as -20 °F may be required in soft clay.

- The frozen earth first forms in the shape of vertical cylinders surrounding the freeze pipes.
- As cylinders gradually enlarge they intersect, forming a continuous wall.

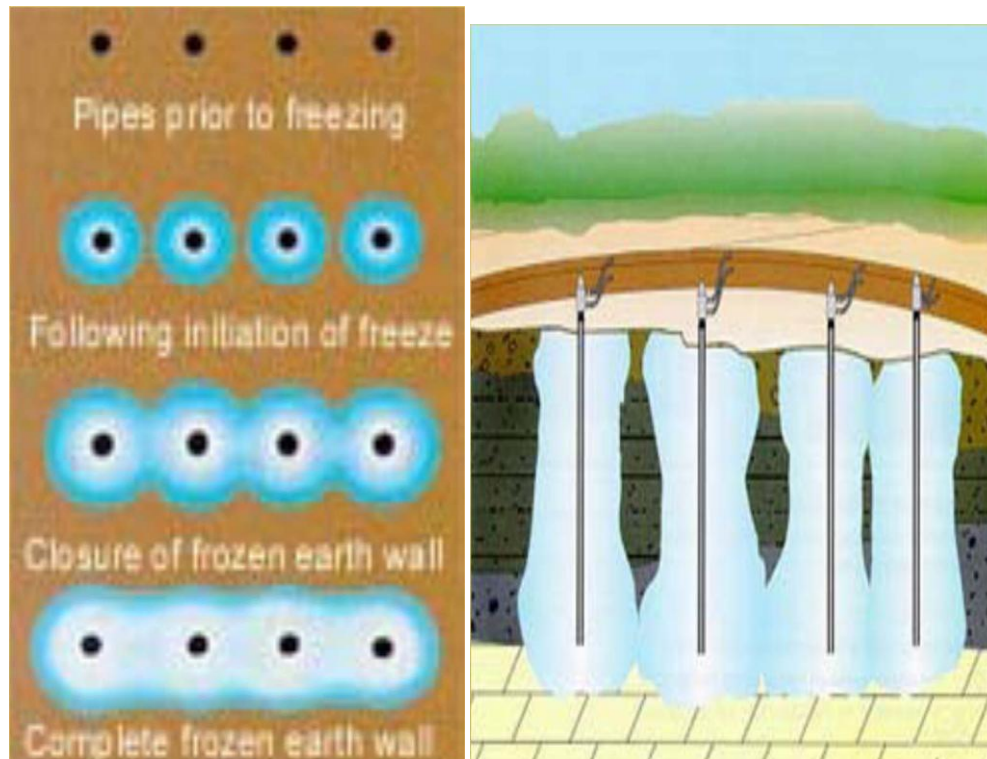

- If the heat extraction is continued at a high rate, the thickness of the frozen wall will expand with time.
- Once the wall has achieved its design thickness, the freeze plant is operated at a reduced rate to remove the heat flowing toward the wall, to maintain the condition.

### **Freezing Equipment and Methods**

- The most common freezing method is by circulating brine (a strong saline solution – as of calcium chloride).
- Chilled brine is pumped down a drop tube to the bottom of the freeze pipe and flows up the pipe, drawing heat from the soil.

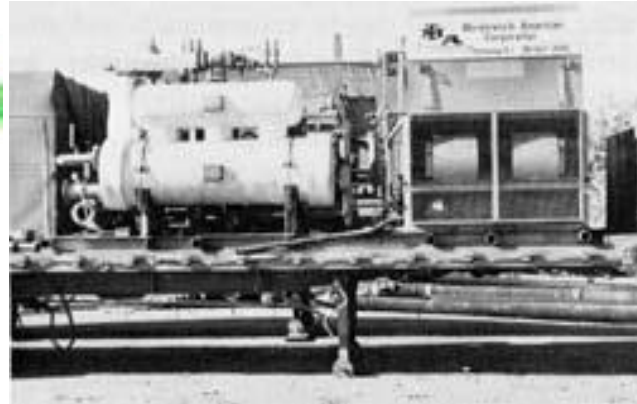
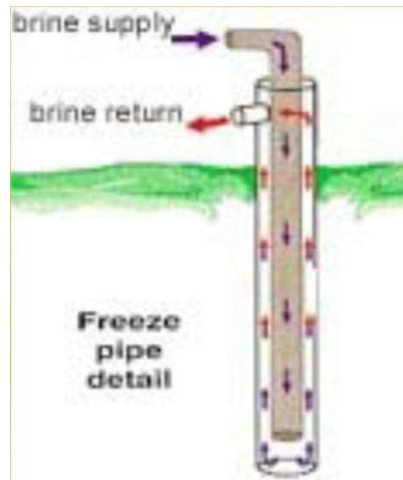

**Technology finds application in the following construction projects:**

- Underpinning
- Tunnel roof freezing
- Freezing of cross-cuts in tunnel tubes
- Clearing out of tunnel fall-ins
- Forcing of framework constructions into railway embankments
- Foundation skirting
- Removal of intact soil samples
- Rehabilitation measures

## UNIT-5

### **EARTH REINFORCEMENT**

Concept of reinforcement - Types of reinforcement material - Applications of reinforced earth – use of Geotextiles for filtration, drainage and separation in road and other works Soil nails are more or less rigid bars driven into soil or pushed into boreholes which are filled with grout. Together with the insitu soil, they are intended to form a coherent.

Reinforced earth has been in use by man since ancient times with the fundamentals of the techniques being mentioned in the Bible The earliest remaining examples of soil reinforcement are the Agar-Quf Ziggurat and the Great wall of China The Romans, Gauls, Dutch and British have been documented using reinforced

# Henri Vidal (re)invents Reinforced Earth in 1963



Henri Vidal  
French Engineer &  
Architect

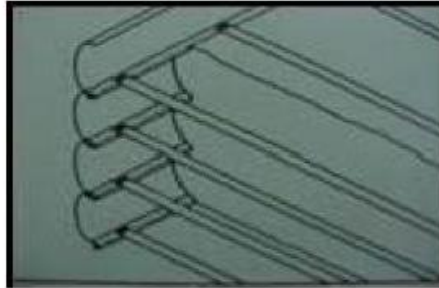

The concept of reinforced soil was accidentally thought about by Mr. Vidal while playing with his children on a beach



1963 : Patent filed for  
Reinforced Earth

An early form of Reinforced Earth using steel strip reinforcement and steel membrane facing

## REINFORCED SOIL

- Soil + reinforcement = reinforced soil
- Reinforcement:
  - Ancient:** Tree branches, grass reeds, straw, roots of vegetation, bamboo, tree trunks
  - Modern:** Steel, polymeric, natural materials
- Soil is strong in compression & reinforcement is strong in tension
- Combined product has much better engineering properties than the individual constituents
- Reinforced soil concept is similar to that of reinforced concrete

Reinforced earth has been in use by man since ancient times with the fundamentals of the techniques being mentioned in the Bible. The earliest remaining examples of soil reinforcement are the Agar-Quf Ziggurat and the Great wall of China. The Romans, Gauls, Dutch and British have been documented using reinforced soil for various applications. The modern concept of earth reinforcement was proposed by Casagrande. He idealized the problems in the form of weak soil reinforced by high strength membranes laid horizontally in layers. The modern form of earth reinforcement was introduced by Henry Vidal in the 1960s. Vidal's concept was for a composite material formed from flat reinforcing strips laid horizontally in a frictional soil. The interaction between the soil and the reinforcing members was solely by friction generated by gravity. This he described as "Reinforced Earth", a term now generally being used to refer to all reinforced works.

### **Applications of reinforced earth for ground improvement. Theory of Reinforcement**

Reinforced earth has been in use by man since ancient times with the fundamentals of the techniques being mentioned in the Bible. The earliest remaining examples of soil reinforcement are the Agar-Quf Ziggurat and the Great wall of China. The Romans, Gauls, Dutch and British have been documented using reinforced soil for various applications.

The modern concept of earth reinforcement was proposed by Casagrande. He idealized the problems in the form of weak soil reinforced by high strength membranes laid horizontally in layers. The modern form of earth reinforcement was introduced by Henry Vidal in the 1960s. Vidal's concept was for a composite material formed from flat reinforcing strips laid horizontally in a frictional soil. The interaction between the soil and the reinforcing members was solely by

friction generated by gravity. This he described as "Reinforced Earth", a term now generally being used to refer to all reinforced works.

### **Principle of Reinforced Earth**

It is analogous to reinforced concrete but direct comparison is not completely valid. The mode of action of reinforcement in soil is to carry tensile loads or anisotropic reduction of normal strain rate. Introduction of reinforcement into soil results in interaction between the two. The interaction

between the soil and reinforcement can be in the form of either adhesion or friction Failure can occur only if the adhesion or frictional force is overcome or the reinforcement itself ruptures The reinforcement disrupts the uniform pattern of strain that would have developed if it did not exist

## Basic principle of reinforced earth

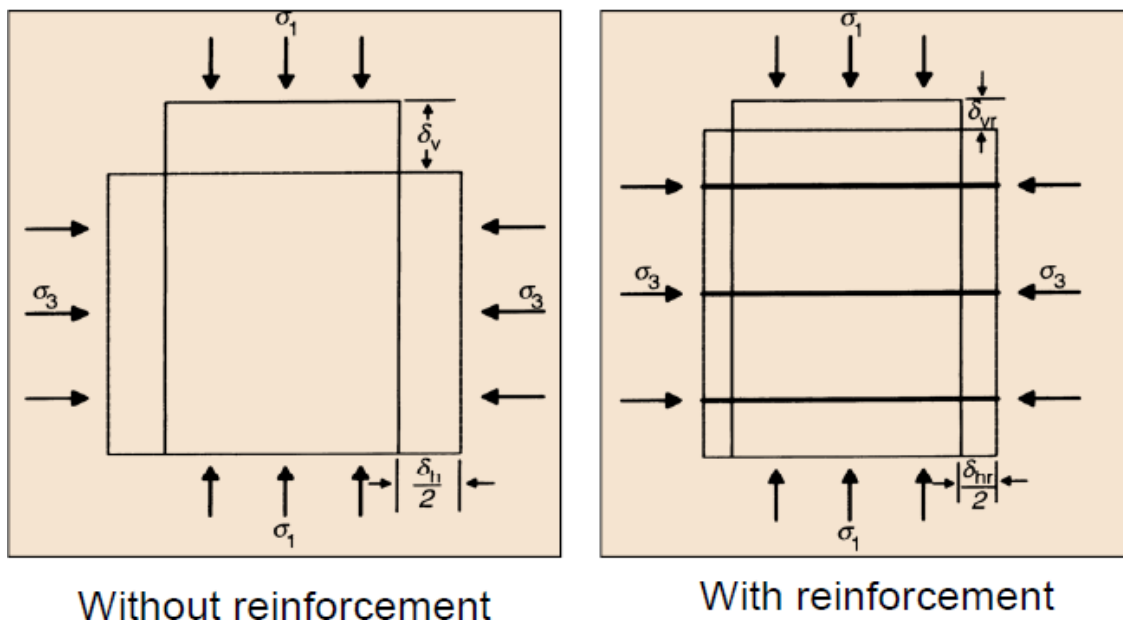

### REINFORCED EMBANKMENTS ON SOFT FOUNDATIONS

The design and construction of embankments on soft foundation soils is a very challenging geotechnical problem. As noted by Leroueil and Rowe (2001), successful projects require a thorough subsurface investigation, properties determination, and settlement and stability analyses. If the settlements are too large or instability is likely, then some type of foundation soil improvement is warranted. Traditional soil improvement methods include preloading/surcharging with drains; lightweight fill; excavation and replacement; deep soil mixing, embankment piles, etc., as discussed by Holtz (1989) and Holtz et al. (2001a). Today, geosynthetic reinforcement must also be considered as a feasible treatment alternative. In some situations, the most economical final design may be some combination of a traditional



foundation treatment alternative together with geosynthetic reinforcement. Figure 2a shows the basic concept for using geosynthetic reinforcement. Note that the reinforcement will not reduce the magnitude of long-term consolidation or secondary settlement of the embankment.

## **REINFORCED STEEP SLOPES**

The first use of geosynthetics for the stabilization of steep slopes was for the reinstatement of failed slopes. Cost savings resulted because the slide debris could be reused in the repaired slope (together with geosynthetic reinforcement), rather than importing select materials to reconstruct the slope. Even if foundation conditions are satisfactory, costs of fill and right-of-way plus other considerations may require a steeper slope than is stable in compacted embankment soils without reinforcement. As shown in Fig.3, multiple layers of geogrids or geotextiles may be placed in a fill slope during construction or reconstruction to reinforce the soil and provide increased slope stability. Most steep slope reinforcement projects are for the construction of new embankments, alternatives to retaining walls, widening of existing embankments, and repair of failed slopes.

Another use of geosynthetics in slopes is for compaction aids (Fig. 3). In this application, narrow geosynthetic strips, 1 to 2 m wide, are placed at the edge of the fill slope to provide increased lateral confinement at the slope face, and therefore increased compacted density over that normally achieved. Even modest amounts of reinforcement in compacted slopes have been found to prevent sloughing and reduce slope erosion. In some cases, thick nonwoven geotextiles with in-plane drainage capabilities allow for rapid pore pressure dissipation in compacted cohesive fill soils.

## **GROUND ANCHORS**

An **earth anchor** is a device designed to support structures, most commonly used in geotechnical and construction applications. Also known as a **ground anchor**, **percussion driven earth anchor** or **mechanical anchor**, it may be impact driven into the ground or run in spirally, depending on its design and intended force-resistance characteristics.

Earth anchors are used in both temporary or permanent applications, including supporting retaining walls, guyed masts, and circus tents.

## Typical applications

---

Earth anchors are typically used in civil engineering and construction projects, and have a variety of applications, including:

- Retaining walls, as part of erosion control systems.<sup>[1]</sup>
- Structural support of temporary buildings and structures,<sup>[2]</sup> such as circus tents and outdoor stages.
- Tethering marine structures, such as floating docks and pipelines.
- Supporting guyed masts, such as radio transmission towers.
- Anchoring utility poles and similar structures.
- Drainage systems, for loadlocking and restraining capability to happen simultaneously
- Landscape, anchoring trees, often semi-mature transplants. .
- General security, as in anchoring small aircraft.
- Sporting activities, such as slacklining or abseiling.

A rock bolt is a long anchor bolt, for stabilizing rock excavations, which may be used in tunnels or rock cuts. It transfers load from the unstable exterior, to the confined (and much stronger) interior of the rock mass.

A rock bolt is a long anchor bolt, for stabilizing rock excavations, which may be used in tunnels or rock cuts. It transfers load from the unstable exterior, to the confined (and much stronger) interior of the rock mass. Rock bolts were first used in mining starting in the 1890s, with systematic use documented at the St Joseph Lead Mine in the US in the 1920s. Rock bolts were applied to civil tunneling support in the US and in Australia, starting in the late 40s. Rock bolts were used and further developed, starting in 1947, by Australian engineers who began experimenting with four metre long expanding anchor rock bolts while working on the Snowy Mountains Scheme.

As shown in the figure, rock bolts are almost always installed in a pattern, the design of which depends on the rock quality designation and the type of excavation.<sup>[2]</sup> Rock bolts are an essential component of the New Austrian Tunneling method. As with anchor bolts, there are many types of proprietary rock bolt designs, with either a mechanical or epoxy means of establishing the set. There are also fiberglass bolts which can be cut through again by subsequent excavation. Many

papers have been written on methods of rock bolt desi. Rock bolts work by 'knitting' the rock mass together sufficiently before it can move enough to loosen and fail by unravelling (piece by piece). As in the photo, rock bolts may be used to support wire mesh, but this is usually a small part of their function. Unlike common anchor bolts, rock bolts can become 'seized' throughout their length by small shears in the rock mass, so they are not fully dependent on their pull-out strength. This has become an item of controversy in the Big Dig project, which used the much lighter pull-out tests for rock bolts, rather than the proper tests for concrete anchor bolts. Rock bolts can also be used to prevent rockfall.

### **Soil Nailing**

Soil nailing is a process of retaining soil by the incorporation of a large number of reinforcements, in the form of „nails“, in the soil which are free at the farther end, the other end being anchored to a thin grouted concrete wall (Fig.25.15,also see Fig.25.16). It is a variant of the reinforced earth construction with the main difference that, whereas in reinforced earth the reinforcing strips are laid and the backfill soil compacted above in layers (Sec.25.5), in soil nailing, short lengths of stiff iron rods are driven into the soil, securing them at the facing wall. In either case the mechanics of retention is based on the friction developing at the interface between the reinforcement and the soil. In order to protect the nail, and to enhance interface friction, the nail surfaces can be pressure-grouted with cement grout. Since no bulb is formed at the end, it is not a system based on point anchorage as in ground anchors, but on continuous friction anchorage as in reinforced earth. For this a large number of nails are driven at closer spacing as in reinforced earth rather than a few anchor rods at wider spacing as in ground anchors. Soil nailing can be temporary or permanent. Figs. 25.17 and 25.18 show two examples of permanent nailing. The former illustrates a scheme for retaining the soil face vertically adjacent to a multilevel car parking structure, and the latter, for cutting a steep and deep slope keeping the buildings above stable and intact. Soil nailing is an effective alternative where existing structures are so close that ground anchors cannot be laid under them due to objection from the property owners. Further, nailing can be carried out with simpler and lighter equipments which can be manoeuvred without much difficulty within limited spaces where space restrictions exist. Also, its flexibility enables its adoption to varying ground conditions. Soil nailing was originally introduced in France in the 1970s. It can be described as an in-situ reinforcing of soil using an array of nails installed as passive inclusions in a grid. The construction begins with the

excavation of a shallow cut (Fig.25.19) on the face of which wire mesh is laid followed by applying shotcrete to the face. When the latter is set, soil nails are drilled through the shotcrete and grouted, followed by 9 anchoring them to the wall. The sequence is repeated until the final depth is reached. The nail being rigid, unlike the reinforcing strip in reinforced earth, can resist some bending and shear in addition to axial tension. An innovative step is the use of screw nails which are installed by rotation (like screw piles), giving rise to enhanced friction at the soil-nail interface. (This is akin to increased bond in the case of deformed reinforcement bars.)

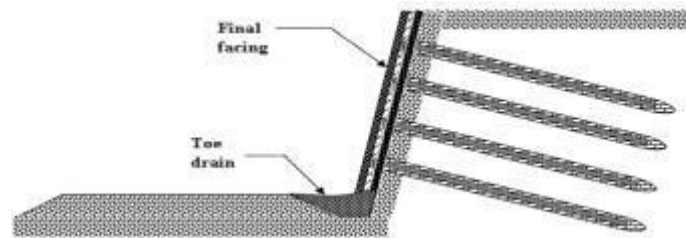

#### **VARIOUS TYPES OF SOIL NAILING:-**

Various types of soil nailing methods that are employed in the field are listed below:

- **Grouted Nail:** After excavation, first holes are drilled in the wall/slope face and then the nails are placed in the predrilled holes. Finally, the drill hole is then filled with cement grout.
- **Driven Nail:** In this type, nails are mechanically driven to the wall during excavation. Installation of this type of soil nailing is very fast; however, it does not provide a good corrosion protection. This is generally used as temporary nailing.
- **Self-Drilling Soil Nail:** Hollow bars are driven and grout is injected through the hollow bar simultaneously during the drilling. This method is faster than the grouted nailing and it exhibits more corrosion protection than driven nail.
- **Jet-Grouted Soil Nail:** Jet grouting is used to erode the ground and for creating the hole to install the steel bars. The grout provides corrosion protection for the nail.

**Advantages of Soil nailing** cannot replace all other methods of soil retention technically or economically. Notwithstanding the same, it has the following advantages.

- 1) It is not dependent on heavy equipment,
- 2) It is economical where the geometry of the wall is complex and where space restrictions exist,
- 3) Since nails are of low strength steel, the need for corrosion protection stands reduced,
- 4) Construction can be carried out with little disturbance to the environment in terms of noise and vibration.

In respect of facing, it must, however, be stated that mere shotcreting is not aesthetically pleasing; the same must either be supplemented or give way to more appealing facing methods. We shall close this section with an example of temporary soil nailing than can be used in construction sites to secure the faces of cuts.

#### **Disadvantages of Soil nailing**

- Soil nail walls may not be appropriate for applications where very strict deformation control is required for structures and utilities located behind the proposed wall, as the system requires some soil deformation to mobilize resistance. Deflections can be reduced by post tensioning but at an increased cost.
- Existing utilities may place restrictions on the location, inclination, and length of soil nails.
- Soil nail walls are not well suited where large amounts of groundwater seep into the excavation because of the requirement to maintain a temporary unsupported excavation face.
- Permanent soil nail walls require permanent, underground easements.
- Less suitable for coarse grained soil and soft clayey soil, which have short self-support time, and soils prone to creeping.
- Suitable only for excavation above groundwater.

## **Rock Bolting:**

Intended to mobilize the inherent strength of a jointed and fragmented mass of rock by active or passive confinement.

### **Principles of rock mass modification by bolting**

- Rock is like soil a natural material occurring in on infinite variety of forms. Its engineering properties show enormous unexpected variability
- While designing major tunnels, underground openings excavations, foundation abutments and slopes in rock the civil engineers are teamed up with a geologist for best possible understanding of the structure and quality of rock formation.
- The mechanical behavior of a rock mass differ because of joints, fractures and other discontinues.
- Insitu modification of rock is mainly aimed at changing rock mass properties rather there rock substance.
- Rock bolting is involved in tunneling and is the construction of large underground openings.

### **Rock bolts have two basic functions**

- To pin or nail well-defined blocks or slabs of rock on to a more stable formation.
- To form a new structural entity cut of jointed rock by applying compressive stresses.

In both cases attempt is made to preserve or mobilize the inherent shear strength of rock along existing joints and potential fractures by a direct increase of the normal stresses in the failure planes or by controlling deformations so that no loosening of rock mass occurs.

## **TYPES OF ROCK BOLTS**

### **Slot and wedge Anchor:**

- The end of its shank is slotted with a wedge partially inserted. As the bolt is pushed against the back of the borehole the wedge is driven home and end of the shank expands and anchors the bolt in rock.
- The bolt is tensioned by tightening a nut against a plate placed on the rock face
- Anchor performs well in hard rock but is unreliable in poor quality rock.

## Granted bolts

- Granted bolts are preferred for permanent reinforcement because they provide a better bond between the bolt and the rock.
- Granted bolts are less prone to corrosion if the face plate fails, the bolt force is still transferred to the rock by means of grout bond
- Grout may be a non shrinking cement mix or a resin.

## Rock bolt action around an excavation

- Rock bolts create compressive stresses perpendicular to the free surface of the excavation.
- This creates a zone of strengthened rock which may resemble a structural element such as an arch or a beam which stands up without additional steel or timber support.

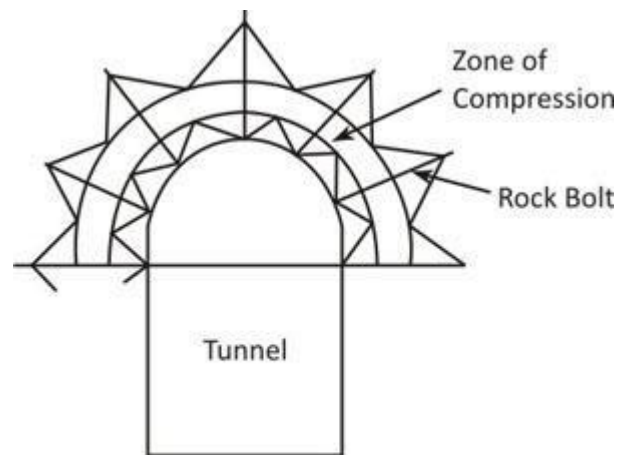

Formation of a strengthened zone through rock bolt

- Rock bolts must be applied as soon as possible after excavation the rock must be restrained promptly because any loosening of the rock add more weight onto the support system.

## Design Rules

- The ratio of bolt length to bolt spacing should be not less than 2, this is to ensure that overlap of zones of pressure between adjacent bolts is sufficient to create a zone of

approximately uniform compression with a thickness equal to about  $\frac{1}{3}$  of the bolt length.

- The length of the bolt should not be less than 3 times the width of the joint blocks this is to ensure that the anchorage takes place in blocks not less than two layers behind the surface, although four blocks would be preferable.
- Aim at a bolt spacing and tension sufficient to create a compression of 70 kpa.
- In large excavations the rock bolts should be longer than in small excavations in the same condition.
- 25mm dia hollow core steel bolts were used, grouted with neat cement.



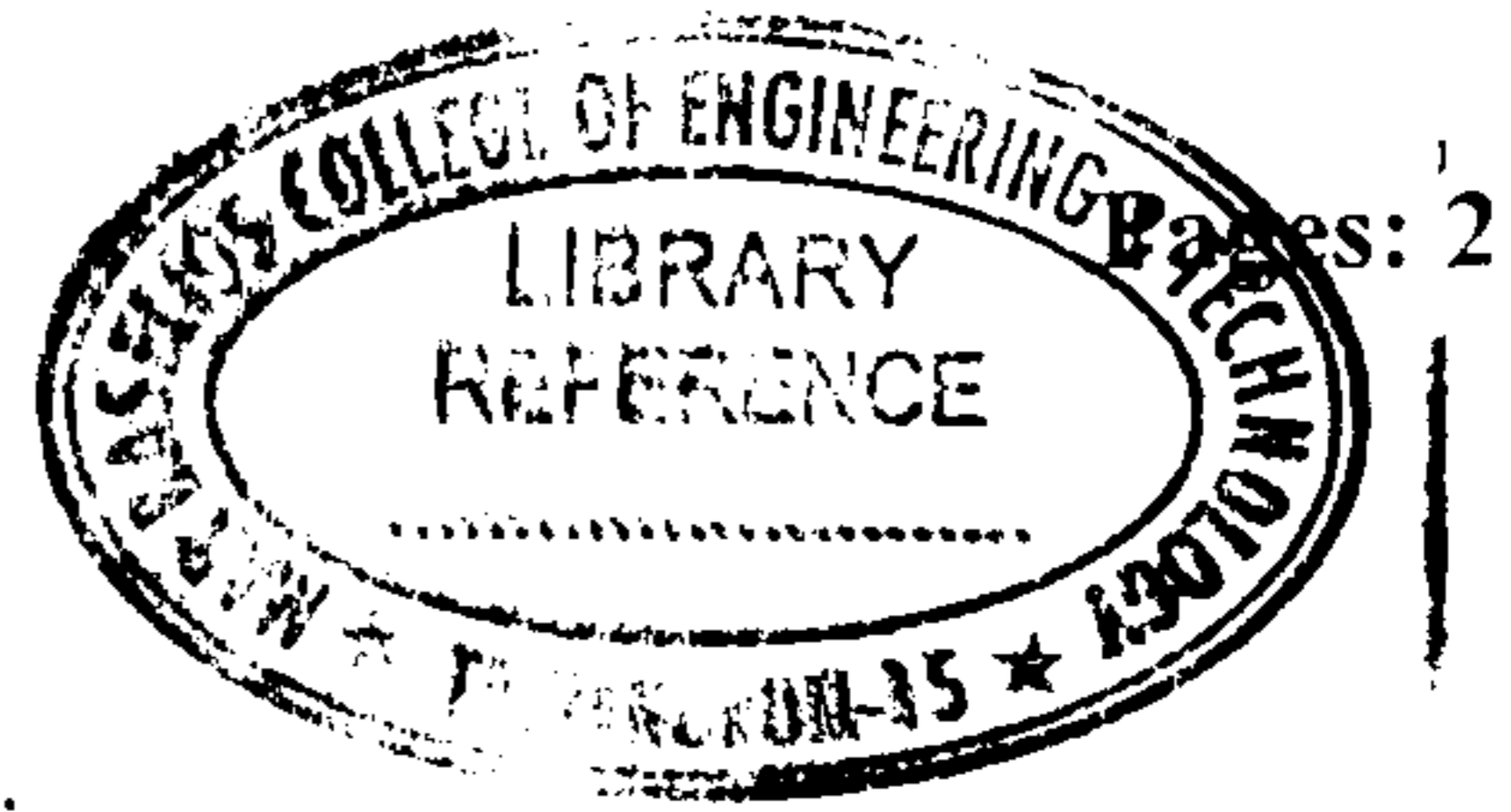

Reg No.: \_\_\_\_\_

Name: \_\_\_\_\_

**APJ ABDUL KALAM TECHNOLOGICAL UNIVERSITY**  
**SIXTH SEMESTER B.TECH DEGREE EXAMINATION(R&S), MAY 2019**

**Course Code: CE362**

**Course Name: Ground Improvement Techniques**

Max. Marks: 100

Duration: 3 Hours

**PART A**

*Answer any two full questions, each carries 15 marks.*

Marks

- |   |  |  |      |
|---|--|--|------|
| 1 | a) Write on Ground Improvement potential.  |  | (5)  |
|   | b) What are the applications of grouting? Describe with the help of neat diagrams. |  | (10) |
| 2 | a) Give notes on different types of ground improvement techniques.                 |  | (8)  |
|   | b) Discuss on permeation grouting.   |  | (7)  |
| 3 | a) What are the aspects and factors affecting grouting?                            |  | (8)  |
|   | b) Write short note on jet grouting.   |  | (7)  |

**PART B**

*Answer any two full questions, each carries 15 marks.*

- |   |  |  |      |
|---|--|--|------|
| 4 | a) What are different mechanisms involved in lime stabilization?                           |  | (5)  |
|   | b) What are ground anchors? What are its components and applications?                      |  | (10) |
| 5 | a) Write short note on lime fixation point and optimum lime content.                       |  | (6)  |
|   | b) List out and explain the effect of lime on physical and engineering properties of soil. |  | (9)  |
| 6 | a) Discuss the process of cement stabilization in the field.                               |  | (7)  |
|   | b) Write short note on soil nailing.   |  | (8)  |

**PART C**

*Answer any two full questions, each carries 20 marks.*

- |   |   |  |      |
|---|---|--|------|
| 7 | a) What is the range of depth of penetration of compaction if a weight of 40,000 kg is dropped from a height of 20 m on the ground surface? |  | (8)  |
|   | b) Write short note on the methods of dewatering.   |  | (12) |
| 8 | a) What are different compaction control tests in the field? Explain.   |  | (10) |
|   | b) Write short note on well point systems.  |  | (10) |

- 9 a) Discuss on the properties of compacted soil. (10)
- b) Differentiate between vacuum dewatering and electro osmosis. (5)
- c) List out different types of compaction techniques for ground improvement. (5)

\*\*\*\*